

Client Handbook

for clients of Clearstream Fund Centre S.A.

Disclaimer: This document is provided to existing clients of Clearstream Banking S.A. and/or Clearstream Fund Centre S.A. for information on future planned changes. It is a preliminary draft and its contents may be subject to amendments.

Document number: 7379

16 December 2024

Information in this document is subject to change without prior notice.

This document is available in electronic format and may be provided in other formats at the discretion of Clearstream Fund Centre S.A. (referred to hereinafter as Clearstream Fund Centre or CFCL). CFCL grants its clients permission to reproduce, store and print this document to the extent deemed reasonable and necessary for receiving from CFCL the services described herein. Any software provided, as set out in the present document, shall be provided under the applicable licence terms.

Unless otherwise stated, all times are given in Central European Time (CET).

© Copyright Clearstream Fund Centre S.A. (2024). All rights reserved.

Foreword

Clients' overall contractual relations with CFCL are governed by the General Terms and Conditions as amended from time to time. Clients agree to abide by these rules when they request a Service from CFCL. Clients can obtain copies upon request from their Client Services Officer or Client Relationship Manager. The General Terms and Conditions can also be found on the website.

This Client Handbook is designed to provide Clients of Clearstream Fund Centre S.A. (also referred to as "CFCL" in this publication) with an overview of CFCL, its organisation and its operational procedures. It is a Governing Document as defined in CFCL's General Terms and Conditions and is subject to the General Terms and Conditions unless otherwise specified.

Information or notifications communicated by CFCL to its Clients in any form whatsoever is not and shall in no case be considered as investment advice.

This version of the Client Handbook replaces all previous editions of the Client Handbook and shall take effect immediately. This Client Handbook shall remain in effect until Clients are otherwise notified.

The Client Handbook is intended to be used in conjunction with other CFCL publications that give further details of how to use CFCL's services.

CFCL reserves the right to update and amend this Handbook from time to time, to reflect the availability of new products and improvements to existing services.

Clients who have specific questions concerning the information contained in this Client Handbook are advised to contact CFCL Client Services or their Relationship Manager.

In the event of any conflict between the General Terms and Conditions and the Client Handbook and other Governing Documents, the General Terms and Conditions shall prevail.

The English version of the Client Handbook is legally binding and shall prevail over any translation which has been provided for commercial reasons only.

This page has intentionally been left blank.

Contents

Foreword	i
1. Introduction	
1.1 Corporate structure	1-1
1.2 Compliance	1-3
1.3 Communications with CFCL	1-4
1.4 Access to CFCL	1-4
1.5 Client services	1-5
1.6 Deadlines	1-6
1.7 Sources of information for clients	1-6
1.8 Fund Market Groups (FMG) definitions	1-7
1.9 Disclosure requirements for Investment Funds	1-9
2. Client accounts	
2.1 Types of accounts	2-1
2.2 Account opening and maintenance	2-2
3. Distribution support services	
4. Custody Business Operations - Fund Acceptance	
4.1 Eligibility Assessment	4-1
4.2 Client Suitability	4-2
5. Order Routing Services	
5.1 Vestima order routing	5-1
6. Settlement Services	
6.1 Types of Settlement instructions	6-1
6.2 Instruction deadlines	6-2
6.3 Instruction format	6-3
6.4 Provision checks	6-4
6.5 Settlement sequence	6-4
6.6 Matching requirements	6-7
6.7 Settlement report	6-9
6.8 Interest claims	6-9
6.9 Short selling	6-9
6.10 Hold/Release mechanism for securities settlement instructions	6-10
6.11 Partial settlement for internal and Euroclear instructions	6-11
6.12 CSDR Settlement Discipline Regime	6-13
7. Cash Financing Services	
7.1	Cash management and Financing 7-1
7.2 Settlement currencies and Cash Correspondent banks	7-1
7.3 Cash instruction processing	7-2
7.4 Cash instruction types - Missed cash deadlines	7-6
7.5 Foreign Exchange services	7-13
7.6 Financing: availability of funds	7-22
7.7 Collateral valuation	7-23
7.8 Interest calculations and reporting	7-25
7.9 Income main transfer account	7-26

8. Asset Servicing

8.1	Income services	8-1
8.2	Corporate action services	8-2
8.3	Event notifications and entitlement forecast	8-10
8.4	Payment management of asset servicing proceeds	8-16
8.5	Transaction management	8-17
8.6	Tax services	8-24
8.7	General Meetings Service	8-30

9. Communications media

9.1	CFS Portal	9-1
9.2	File Transfer	9-1
9.3	Swift	9-2
9.4	Vestima and VestimaPRIME order routing via FIX	9-3
9.5	Contingency communication	9-3

10. Reports and information services

10.1	Choice of reports	10-1
10.2	Reconciliation	10-1
10.3	Connectivity Channels	10-2
10.4	Monthly billing reports	10-10
10.5	Client documentation	10-10
10.6	Registrar Monitoring Report	10-10
10.7	VestimaPRIME Enhanced Pricing and Reference Data Service (Alternative Funds Data)	10-11

Glossary	G-i
-----------------	------------

1. Introduction

This introduction is for general information purposes only.

Clearstream Fund Centre S.A. (hereby also referred to as "CFCL") is a public limited liability company (société anonyme) under Luxembourg law (registered with the trade and companies register of Luxembourg under registration number B 261.691), fully owned by Deutsche Börse AG ("DBAG").

CFCL is supervised by the Commission de Surveillance du Secteur Financier (CSSF).

1.1 Corporate structure

The information contained in this section is not intended to provide professional legal advice and should not be relied upon in that regard. CFCL makes no guarantees, representations or warranties and accepts no responsibility or liability as to the accuracy or completeness of the information, and under no circumstances will it be liable for any loss or damage caused by reliance on any opinion, advice or statement made in this document.

Clearstream Fund Centre S.A. in Luxembourg

Clearstream Fund Centre S.A. (CFCL) was incorporated on 16 November 2021 in Luxembourg.

CFCL is an indirect subsidiary of Deutsche Börse AG (DBAG), as it is a wholly owned direct subsidiary of a holding company based in Luxembourg, Clearstream Fund Centre Holding S.A. (CFCH), which in turn is a 100% direct subsidiary of DBAG, together with Clearstream Fund Centre AG (CFCS), a distribution support platform.

CFCL is the parent company of Clearstream Australia Ltd. (CAL) and Clearstream Fund Centre S.A. Cork Branch. It is part of the Clearstream Fund Services (CFS) business of Deutsche Börse, with a focus on:

- Distribution Support Services;
- Receipt and Transmission of Orders (RTO);
- Acceptance of deposits and other repayable funds;
- Payment services;
- Safekeeping and administration of financial instruments for the account of Clients, including custodianship and related services such as cash/collateral management and excluding providing and maintaining securities accounts at the top tier level ("central maintenance service");
- Foreign exchange services where these are connected to the provision of investment services.

See on the Clearstream website under [About Clearstream/Company Governance/Shareholding Structure](#).

Clearstream Fund Centre S.A. Cork Branch

Clearstream Fund Centre S.A. Cork Branch supports the order processing of CFCL by providing back office and data processing functions. Clearstream Fund Centre S.A. Cork Branch is not itself a regulated entity, but its activities are controlled under EU passporting arrangements for the provision of services to CFCL. Clearstream Fund Centre S.A. Cork Branch also provides intercompany services to other DBAG entities, such as the group's IT User Helpdesk.

Luxembourg regulators

The CSSF is the national competent authority and Luxembourg's prudential supervisor, responsible for the good operation, quality and compliance of financial institutions incorporated in Luxembourg, as stated in the law of 5 April 1993, as amended, which regulates the financial sector in Luxembourg.

CFCL is subject to the relevant CSSF circular letters and other requirements. Moreover, CFCL operates as a CSSF-authorized full bank, compliant with Directive 2014/65/EU of the European Parliament and of the Council of 15 May 2014 on markets in financial instruments (MiFID).

1.2 Compliance

The Client shall comply - and ensure compliance by any of the Client's underlying Clients up to the ultimate legal and beneficial owner - with any national or foreign law, regulation, sanction, order, judgment, injunction, asset freeze, blocking regulation or order or any other act or action of, or by, any national or foreign government, authority, court, (self-) regulatory organisation, government agency or instrumentality of government, including, but not limited to, investment and holding restrictions ("Regulations") applicable to the Client, its underlying Clients or CFCL (including Regulations not applicable to the Client but applicable to CFCL). The Client shall not, by action or inaction, cause CFCL to violate a Regulation and shall be liable for and hold CFCL harmless against any direct or indirect loss, claim, damage, liability or expense, imposed on or incurred by or asserted against CFCL in connection with any actual or alleged non-compliance with the aforesaid by the Client or any underlying Client of such Client up to the ultimate and legal beneficial owner.

The Client understands and acknowledges that transactions and accounts involving securities issued or held for custody in the European Union (EU), EU Member States, the United States or other nations are subject to the laws and regulations of those jurisdictions, some of which have extraterritorial application. As a legal person organised under the laws of Luxembourg, an EU Member State, CFCL is in all cases subject to applicable Luxembourg and EU laws and regulations. Insofar as CFCL conducts its business through U.S. persons, including foreign subsidiaries or affiliates of U.S. persons, the U.S. government may assert jurisdiction over transactions in securities neither issued nor held for custody in the United States. CFCL conducts its business to comply with all laws applicable to CFCL. Please also refer to the [EU sanctions](#) page.

Important Note: As part of CFCL's internal compliance procedures, all incoming Client instructions will be automatically scanned before entering transaction processing. Instructions that are internally flagged as requiring further manual investigation are set to status pending, with such status immediately reported to the Client via their chosen media channel(s), until either being manually released for processing or rejected. In order to ensure that instructions being investigated do not miss the applicable deadlines, Clients are advised to input instructions at least 15 minutes before the associated deadline.

1.3 Communications with CFCL

Day to day communication in relation to the services described in this Client Handbook is handled by CFCL. This covers all communication media such as phones, Swift messages or other electronic forms of communication.

Clients can send instructions to CFCL, and receive reports, using the CFS Portal suite of products. The CFS Portal suite of products encompass the CFS Portal UI, File Transfer, Swift and FIX.

These connectivity media and the conditions for their usage are described in [Chapter 9](#). Information about sending instructions to CFCL is given in [Chapter 6](#) (Settlement services) and [Chapter 7](#) (cash financing services), and the reports available through the various connectivity media are described in [Chapter 10](#).

1.4 Access to CFCL

Access to products and services

CFCL's Client base is fully international, and Clients are numbered among the most influential and prestigious financial institutions in the world. Clients have access to one or more services and products provided by CFCL as further detailed in the Governing Documents or separate and specific written agreements.

The different categories of CFCL Clients are set out in accordance with Directive 2014/65/EU of 15 May 2014 on markets in financial instruments (MiFID) and amending Directive 2002/92/EC and Directive 2011/61/EU, including as per Article 4(1) the investment firm definition:

- "Investment firm" means any legal person whose regular occupation or business is the provision of one or more investment services to third parties and/or the performance of one or more investment activities on a professional basis.

Prior to the provision of any services from CFCL, Clients shall be informed of their categorisation in accordance with Article 24 of Directive 2014/65/EU (MiFID) and Article 45 of Commission Delegated Regulation (EU) 2017/565.

CFCL can provide services only to Clients who are categorised as "Eligible Counterparties" under MiFID as CFCL is discharged from certain MiFID II rules (conduct of business obligations, the obligation to execute order on terms most favourable to the Client, disclosure duties) in providing services to Eligible Counterparties.

CFCL will ask each Client to provide necessary documents to CFCL to allow confirmation of the Client's "Eligible Counterparty" status.

Access to CFCL Services shall be requested by the completion of the relevant application forms made available on the website and is subject to the participation criteria and the relevant outcome on the risk assessments, set out in accordance with Article 16 of Directive 2014/65/EU (MiFID). Details on the criteria and categorisation of the Client are available on the website.

1.5 Client services

CFCL's worldwide Client Services units constitute a "Front Line Desk" providing local assistance to Clients in their own time zone, providing 24-hour coverage around the world. Specific contact details are given on the website.

Clients must address their query to Client Services by email or telephone call only. CFCL will revert to the Client in an appropriate and reasonable period of time. Only the CFCL Client is entitled to assess which media is the most appropriate.

For urgent matters and to ensure the best possible response time, it is highly recommended that the Client contacts Client Services by telephone instead of email. CFCL cannot be held responsible for delays in responding to an email.

Note: As is normal practice within financial organisations, CFCL has implemented telephone line recording, in accordance with Article 16 of Directive 2014/65/EU (MiFID). The main purpose of telephone line recording is to ensure that the interests of CFCL and of its Clients are protected against misunderstanding or miscommunications under the provisions of the applicable laws. Recorded telephone conversations may be listened to for the purpose of clarifying the content of business dealings:

- Determine whether business dealings have been conducted;
- Determine the content of business dealings that have been conducted;
- Collate evidence in preparation for arbitration, litigation or private settlement negotiations;
- Determine what information has been provided to third parties including statements made to the press.

If the Client wishes to raise a complaint, CFCL has an effective and transparent process in place for the prompt handling of Clients' or potential Clients' complaints, as described in the Complaints Handling procedure set out in line with Article 16(2) of Directive 2014/65/EU (MiFID) and Article 26 of Commission Delegated Regulation (EU) 2017/565.

1.6 Deadlines

All deadlines quoted in hours and minutes (hh:mm) should be understood to include ":00 seconds CET". For example, 16:00 should be understood to mean 16:00:00 CET.

Compliance with a deadline is assessed against the respective "Clearstream Receive Timestamp". An instruction will be processed automatically provided that the "Clearstream Receive Timestamp" indicates a time before the related deadline. If the "Clearstream Receive Timestamp" of an instruction indicates a time on or after the related deadline, the instructions can be processed on a "best efforts" basis only.

1.7 Sources of information for clients

Clients can make specific enquiries and obtain further information about all of CFCL's products and services from Client Services or from their Relationship Manager.

CFCL supports its products and services with a range of user documents and other sources of Client information. Some of these documents, when classified as Governing Documents, are contractually binding on the Client as set out in the General Terms and Conditions.

The website provides information about all of CFCL's products and services and is a centralised repository for all current publications. It also provides up-to-date information about activities and events being held by CFCL.

Client publications

CFCL maintains a number of publications that are provided in soft copy form via the website and updated regularly. The following publications support CFCL's products and services.

Client Handbook

The Client Handbook (this document) is designed to provide CFCL Clients with an overview of CFCL, its organisation and its operational procedures. It is a Governing Document as defined in CFCL's General Terms and Conditions and is subject to the General Terms and Conditions unless otherwise specified.

Market Guides

The Market Guides provide key information, in particular in the area of settlement and asset servicing, on each market where CFCL offers a service. In addition, relevant website addresses are indicated, where more detailed information is provided according to specific needs.

It also includes details about the types of securities traded, types of links, Depositories and agents, Cash Correspondents, settlement rules and times, custody services and foreign exchange.

The Market Guide is organised by market, it is split across five main sections:

- General information;
- Market Infrastructure;
- Regulation;
- Settlement process and services;
- Asset servicing.

The Market Guides are produced in English and the latest applicable version are available on the website.

Client communication manuals

The following documents provide information about the operation of CFCL's connectivity services:

- File Transfer User Manual;

- CFS Portal User Manual;
- Swift User Guide;
- FIX;
- Vestima and Vestima Prime User Guides.

Clearstream Fund Centre Fee Schedule

Fees and charges levied by CFCL for its services are given in the Clearstream Fund Centre S.A. Fee Schedule, which is a Governing Document as defined in CFCL's General Terms and Conditions and is subject to the General Terms and Conditions unless otherwise specified. The CFCL Fee Schedule is available on the website.

Announcements

Announcements give details in English of information about changes in the markets and CFCL's products and services. The information given to Clients in Announcements is integrated, where applicable, into the Client Handbook and other reference documents as appropriate.

Announcements containing governing information are individually defined as Governing Documents on a case-by-case basis.

Publication Alerts services

The Publication Alerts services are free of charge email services that inform Clients of the publication of new / amended information on the website. These services are available to all registered users of the Clearstream Fund Centre website.

Real-time alerts

Real-time alerts provide immediate notification of the availability on the website of new / amended publications that match the Client's preferences as selected when subscribing to the service.

Daily alerts

Daily alerts are emails sent to Clients at the end of each day providing a list of all new / amended publications uploaded to the website during that day. The list includes only those publications that match the Client's preferences as selected when subscribing to the service.

Announcements via email

The email service is designed to enable Clients who do not have desktop access to the internet to receive CFCL announcements as attachments to emails sent over night.

Weekly Update

The Weekly Update includes a list of all new / amended Clearstream Fund Centre publications issued during the preceding week. The list includes only those publications that match the Client's preferences as selected when subscribing to the service.

Statement of Insurance

Clients can request a copy of the Statement of Insurance, which summarises the coverage maintained by CFCL to protect its Clients. This can be obtained upon request from a Client Services Officer or Relationship Officer.

1.8 Fund Market Groups (FMG) definitions

Investment Funds feature complexities depending on the fund structure. In order to account for these distinct complexities, CFCL classifies funds into Fund Market Groups (FMG):

- FMG A: simple mutual funds;
- FMG B: complex mutual funds; and
- FMG C: alternative investment instruments.

FMG A

A fund is classified as A when it is deemed to be an asset that is fully fungible and eligible for an omnibus account in the register of fund shareholders. These funds typically offer easy settlement of cash and securities within CFCL and the order routing of transactions is completely automated.

FMG B

In its simplest form a fund is deemed to be B when it is neither in the category of A or C. For example, we will classify a fund as B if:

- The fund requires manual intervention after order placement - provision of additional documentation for the initial investment;
- The fund offers a daily Dividend option requiring additional focus and monitoring.

FMG C

A fund will fall into the C category when it is clear there are key restrictions within the asset. These restrictions can vary toward type of investor acceptance criteria or where an investor, for example, is restricted in its withdrawal capabilities. Similarly, the investment can be subject to differing types of mandatory fund events such as withdrawal fees or a need for a full documentation submission for every investment.

Disclaimer

Clearstream Fund Centre S.A. publishes the FMG for all eligible investment funds ISINs.

The FMG is determined at the discretion of CFCL based on its assessment of the operational and technical efforts required per investment funds ISIN for Clearstream Fund Centre S.A. and CFCL's supplier Clearstream Fund Centre S.A. to provide services.

When submitting order instructions, relating to any investment funds ISIN through Clearstream Fund Centre S.A., the Client acknowledges awareness of the FMG allocated and the applicable pricing.

The FMG is based on information obtained from third party sources. CFCL endeavours to ensure that such information is correct and up to date but cannot be held liable if there is any change of which it would not have been aware and will not be liable for retrospective reimbursement of amounts charged. In the event of corrections to the FMG, the relevant pricing will only apply to future transactions, as from the date of correction.

1.9 Disclosure requirements for Investment Funds

CFCL applies certain disclosure requirements for Investment Funds that enables an officially appointed agent of the Investment Fund to satisfy the regulatory/KYC/AML obligations and/or to perform all the normal functions, such as calculating contingent deferred sales charges (CDSCs), trailer fees and early redemption fees, for Investment Fund Shares routed via CFCL.

Also refer to the Disclosure Requirements published on the Market Guides.

Highlights of the disclosure requirements

If required by the applicable legislation, regulations, KYC/AML obligations, and/or for the operation of an Investment Fund (including but not limited to the calculation of fees, tax-related reasons, or providing to the distributor's services for which they have been appointed by the Investment Fund), CFCL will communicate with the regulator and/or the agent of the Investment Fund the respective position and movement information (including the name of the position holder whenever required by the agent). The agent includes, but is not limited to, the TA, the fund Promoter, the fund manager, the fund custodian, the fund Paying Agent and the fund processing agent.

- Agents may outsource parts or all of their functions to third-party service providers. CFCL is authorised to disclose the information to the service provider acting as an attorney of the agent. The disclosure requirements will apply to all Investment Fund Shares routed via CFCL for which such reporting is required to comply with the applicable legislation, regulations, KYC/AML obligations and/or to ensure the operation of the Investment Fund.
- The disclosure requirements of CFCL are designed to ensure compliance with banking secrecy requirements, unless CFCL is obligated by applicable law to disclose the required investor information to authorised requesters.
- CFCL's Wolfsberg Anti-Money Laundering (AML) Questionnaire located on the website provides CFCL's responses to the questionnaire, along with a statement on CFCL's AML preparation.

Background

Applicable laws of different markets may impose an obligation on CFCL to disclose details of the Client (or as required in some cases the ultimate beneficial owners) to regulators and authorised agents of the Investment Fund. The disclosure obligation may be periodic or only upon request.

For most types of Investment Fund, shares are kept in registered form in the shareholder register of an Investment Fund. Shares are registered in the name of CBL, as network provider to CFCL, or of the depository acting as a nominee on behalf of CBL.

The reporting of Client information to agents is in fact necessary to enable them to calculate, in accordance with the terms of the Investment Fund Prospectus, components such as the following:

- Contingent deferred sales charge (CDSC) - A "back-end" sales charge paid by the shareholder when selling shares. The rate applied for a CDSC varies with the length of time for which a shareholder holds shares, in accordance with the calculation method indicated in the prospectus;
- Early redemption fee - A redemption charge paid by the shareholder when selling shares. The retention period will determine the rate to apply;
- Trailer fee - Sales commission paid to fund distributors according to the number of shares they sell and, in some cases, the length of time for which those shares are held by the individual investors.

Conditions

- The disclosure requirements are applicable to all CFCL Clients and to all Investment Fund Shares routed via CFCL, if such reporting is required for the operation of the Investment Fund.
- The disclosure requirements are applicable for shares held under registered, bearer, certificated or global form.
- The disclosure requirements will remain in effect between CFCL and Clients as long as the contractual relationship is valid.

This page has intentionally been left blank.

2. Client accounts

Each Client account is identified by a unique account number. Clients can settle Transactions and hold Balances in any funds or currency eligible for admission. A range of options is available for each account opened. Clients are asked to specify which options they require when opening an account. Clients who wish to modify any of the options for an account should contact Clearstream Fund Centre Client Services or their Relationship Officer (see Client Services).

2.1 Types of accounts

The following types of accounts are available to Clients:

Main and additional accounts

Clients can open the main account and any number of additional accounts. Additional accounts enable Clients to distinguish between their own holdings (proprietary assets) and those of their underlying Clients (omnibus and segregated third party assets), in order to cater to specific business areas or for other purposes. Main and additional accounts can be used to access Vestima and VestimaPRIME services that allow to safekeep and subscribe for mutual (STP) and hedge (complex) funds respectively.

Dedicated account for French registered securities

French registered securities can be distinguished as VEN (Valeurs Essentiellement Nominatives), VON (Valeurs Occasionnellement Nominatives), LBS (Loyalty Bonus shares) and LBS-PF (Primes de Fidélité). VEN and VON in bearer form can be held on a main or additional account, while for VON in registered form as well as for LBS securities it needs a dedicated account linked to the main or additional account accordingly (one to one relation).

Documents, static and dynamic data are constantly being updated and expanded in different languages. CFCS, if notified by the fund providers, can additionally forward relevant information on investment funds and changes in the range of funds to distribution partners.

New investment funds and/or share classes are continuously being added to the CFCS universe.

The distribution partner can additionally access Clearstream Fund Centre S.A 's Super User functionality within CFCL Fund Compass to administer the accesses and rights of its users.

Third party assets: Omnibus versus segregated account

When opening a new account, Clients must indicate the nature of the assets to be kept therein (proprietary assets or third-party assets). For third-party assets, Clients can choose between omnibus (where interests of several underlying Clients are mixed) or segregated accounts. For segregated accounts, Clients must provide the identity of the underlying Clients (whether or not the beneficial owner) in the account application form and must immediately inform CFCL of any change thereafter. The underlying Client details required on the account application form are as follows:

- Legal contact name;
- Address containing city, post code and country;
- Commercial register number (where applicable);
- Swift/BIC (where applicable).

These details will be recorded by CFCL in a specific business partner register which will be used for Know Your Client (KYC) and Anti-Money Laundering (AML) purposes. Omnibus and segregated accounts for third party assets are only eligible for credit facilities if the Client provides collateral for these

facilities from another account that contains proprietary assets. Further details concerning the operation and opening of these accounts can be obtained on request from Clearstream Fund Centre Client Services or a Relationship Officer.

One Account, Vestima, VestimaPRIME service

Client can subscribe to the One Account service specifying holding type "All funds", allowing to connect one single account to both Vestima and VestimaPRIME simultaneously. One Account Clients are enabled to safekeep mutual (STP) and alternative funds in one single account.

Client can specify to subscribe to the Vestima Service specifying Holding type "Simple". Clients on this model are enabled to safekeep securities on Fund processing group (FPG) Vestima only.

Client can subscribe to the VestimaPRIME Service specifying Holding type "Complex". Clients on this model are enabled to safekeep securities on Fund processing group (FPG) VestimaPRIME only.

Fund Issuance Accounts (FIA)

Central Facility for Funds (CFF) Settlement Agents can open one or more FIAs in CFCL for exclusive use in processing credits and debits of CFF Qualified Investment Fund Shares and related settlement Transactions. An ISIN category of CFF Qualified Investment Fund Shares can be maintained in one FIA only. CFCL can, at its own discretion, act as a CFF Settlement Agent by opening and operating one or more FIAs. CFCL will generate Transactions based on confirmations received from a CFF Transfer Agent that ensures the relevant Investment Fund Register is updated.

Published and Unpublished Accounts

The main account of every Client is usually published: the existence of the account, including the account number and account name, is available through query functions available via CFS Portal or the website. Upon request and at CFCL's discretion, a Client can open an Unpublished Account. Unpublished Accounts are not listed in any printed publication. Additional accounts, and Client money accounts, are generally opened as Unpublished Accounts. It is not normally necessary to divulge the existence of these accounts to counterparties, settlement with counterparties is normally executed using the Client's main account.

2.2 Account opening and maintenance

Opening a main CFCL account

Questions relating to the procedures for opening a first main account should be directed to a Relationship Officer.

The application forms that must be completed and returned by mail to CFCL to request the opening of a CFCL main account are as follows:

- Client Application Form, duly signed (in original form), DocuSign option for all the originals;
- Account Application Form, duly signed (in original form).

Separate forms are also completed to subscribe to a communications medium.

The application forms for CFS Portal, File Transfer and Swift can be provided upon request and are available from the website. Likewise, the Vestima Service Application Form, the Vestima Set Up Form and the Fund Management Shareholder Reporting Agreement can be provided upon request.

Applicants must also submit (in original form):

1. An up-to-date, official and complete list of authorised signatures. Please provide original documents.

2. Certified¹ true copy of the articles of association¹ and, if the articles are not available in English, French or German, a certified¹ English translation.
3. Certified¹ true copy of the licence² to operate as a financial institution under Luxembourg law or any equivalent category under the Client's national law and, if the license is not available in English, French or German, a certified¹ English translation.
4. Extract of the company's register¹ (official or certified copy) including certificate of residency and, if the document is not available in English, French or German, a certified¹ English translation.
5. A copy of the company's most recent audited Annual Report¹. In the case of a subsidiary, please also provide the latest audited Annual Report of the parent company.
6. U.S. Patriot Act certification (if applicable).
7. Additional documents¹ required in case an official signatory list has not been transmitted, or in case of a specific delegation of the signature authorities to individual or legal persons by board members:
 - Certified true copy of minutes of appointment of directors (board resolution).
 - Certified signed accompanying letter of directors appointing authorised signatories, whereby directors' signatures have been certified correct by notary or equivalent (in case the accompanying letter is not certified in this way, please provide certified true copies of the passports of the directors appointing signatories).
 - List of authorised signatures signed by appointing directors.
8. Detailed report written on your company by a recognised rating agency (if available).
9. The FATCA self-certification form, duly filled in.
10. The Controlling Persons tax residency self certification form, duly filled in and signed.
11. The Entity tax residency self-certification form, duly filled in and signed.
12. The Client Identification Template.
13. Other documents deemed relevant for the provision of services offered by CFCL (EID, Central Coordinator Form, Account Application Form and the Fund Management Shareholder Reporting Agreement).
14. Original or certified true copy of the shareholder structure showing ownership and assets. If not available in English, French or German, a legal English translation.
15. Relevant Due Diligence industry templates (Original or certified true copy of Wolfsberg Questionnaire, Original or certified true copy of FCCQ for proprietary business and Original or certified true copy of ISSA Form and CBDDQ for client's client business), duly filled in and signed.
16. Original or certified true copy of the Organizational Chart (BoD/Executive Management Structure - NBO + UBO).

Requests to open a CFCL account should be addressed to the attention of the Client Relations Department. When a request by a new Client to open an account is approved, the new Client is notified by Swift or letter. The Client then receives by standard mail the necessary information for using a CFCL account.

This includes the account number, passwords (where applicable) and relevant CFCL publications. CFCL reserves the right not to accept an application for a CFCL account from a new Client and is not obliged to disclose its reasons for so doing.

1. Certified copies of company documentation (articles, licence, minutes, signatures list) to be made by a competent authority under Luxembourg regulation or under the national regulation of the applicant's jurisdiction (such as notary, embassy, police officer). Proof of the competency of the authority to certify copies must be attached for Clients not under Luxembourg regulation.

2. In this case, specific agreements must be signed.

Opening additional CFCL accounts

Additional accounts can be opened without repeating the full initial application procedure. In order to request the opening of an additional account, Clients must apply, either, via CFS Portal message, by sending an authenticated Swift message or a duly completed Account Application Form or a letter bearing authorised signatures to the attention of Banking Operations (Account Administration).

The request must also include details of:

- The main account number;
- The name for the additional account (maximum 35 characters), which must begin with the same name as that of the main account;
- Whether the account is to be a Fund Issuance Account (FIA)²;
- Whether the account is to be published or unpublished;
- Whether the account holding is proprietary or third-party assets;
- For third-party asset accounts, whether the account is to be omnibus or segregated;
- For segregated accounts, indicate the identity of the underlying Clients (to be recorded by CFCL in the business partner register);
 - Legal contact name;
 - Address containing city, post code and country;
 - Commercial register number (where applicable);
 - Swift/BIC (where applicable).
- Indicate a setup reference account (which could be the main account) strictly applicable to:
 - Reports setup (Common Codes/ISINs);
 - Settlement Sequence Option (by transaction reference number, by settlement Date, by nominal amount);
 - Settlement option (mandatory settlement period or for against payment instructions only, mandatory and optional settlement periods);
 - Matching BIC¹ (the matching BIC will be included in the settlement party details of external settlement instructions, only one matching BIC per account is allowed);
 - Mailing address.
- Whether or not the communication links will be the same as for the main account;
- Whether or not securities, cash and/or custody reporting will be the same as for the main account;
- Whether or not the account is to be added to a granted Power of Attorney, indicating the date of the relevant Power of Attorney and the Attorney's name;
- The name and telephone number of a contact person;
- Any special requirements (such as Single Matching Account service, Billing account). Unless the Client instructs CFCL otherwise, CFCL will use, for all additional accounts opened in the Client's name, the same designation for the Account Holder, and the same information on authorised signatures as that provided by the Client for the first account opened. Liability for the fulfilment of all obligations related to such additional accounts remains solely with the Client.

Account maintenance and other fees

All fees are detailed in the Clearstream Fund Centre Fee Schedule which is published regularly.

1. Clients must provide the matching BIC when accessing T2S markets via Vestima.

Closing a CFCL account

Without prejudice of CFCL GTCs, CFCL or the Client can close an account upon one month's written notice. To request the closing of an account, the account owner must apply, either, via CFS Portal message, by sending an authenticated Swift message, or a letter to CFCL, bearing authorised signatures to the attention of Banking Operations (Account Administration). The Swift message or letter must also include instructions for the Clearing of any credit or debit Balances in the account. The Client shall support all due fees, commissions and other charges still to be calculated when closure request reaches Clearstream Fund Centre. The Client shall be released from obligations towards CFCL when CFCL confirms to the Client that the account is closed.

This page has intentionally been left blank.

3. Distribution support services

Clearstream Fund Centre S.A. offers a range of distribution support services to distribution partners through Clearstream Fund Centre AG (hereafter referring to "CFCS"), an automated platform connecting distribution partners and fund providers around the globe.

CFCL enables distribution partners to enter into a distribution agreement with CFCS acting for the account and on behalf of fund providers and to access the web-based platform interface "Compass".

CFCS has developed a new model, in which CFCL is appointed as global distributor by Fund Providers duly represented by CFCS. Under this new model, CFCL is one of the several fund providers represented by CFCS which is mandated by these fund providers to appoint Distributor or Sub-Distributors.

Compass provides fund search and analysis tools as well as static, dynamic and regulatory data and fund documents, all of which support distribution partners in increasing their internal efficiency while meeting regulatory requirements. Additionally, Compass is a modular platform that distribution partners can further customise. The service level applicable to distribution partners depends on their respective service choices as highlighted in the application form separate to the Client Handbook.

This chapter sets out the scope of the distribution support services CFCS provides on behalf of CFCL to distribution partners. It covers:

- Distribution agreement maintenance;
- Fund distribution commission collection;
- Compass and Reporting;
- Clearstream Data Hub;
- Morningstar services;
- ISS ESG Solution;
- Clearstream Product Expert and Service Explorer;
- Quantalys Easypack solution;
- Market Insights.

Distribution agreement maintenance

CFCL relies on CFCS for the contractual relationship with fund providers. CFCS manages the relationship with fund providers by maintaining distribution agreements up to date as well as entering into new distribution agreements with new fund providers.

Distribution partners benefit from new investment funds constantly being added to the CFCS fund universe available under the distribution agreement as well as from any applicable fund distribution commission.

Fund distribution commission collection

CFCL collects fund distribution commissions from fund providers via CFCS as well as manages the payment to distribution partners in accordance with the respective terms. Remunerations are granted only on investment funds listed in Compass and preferably held in a custody account at CFCL. To receive the fund distribution commissions for a specific quarter distribution partners must register the designated custody account with CFCL no later than ten working days before the beginning of the quarter concerned. The fund distribution commissions to be paid to the distribution partners are received from fund providers for payment and proceeds are credited to the distribution partner's designated account on payment date.

Distribution partners who entered into a contractual relationship with CFCL will keep on receiving the payment of their fund distribution commissions in accordance with the terms that CFCS negotiated with fund providers.

Distribution partners are provided with transparent quarterly reporting on remunerations, including details on holdings, currency, fund name and rate.

Compass and Reporting

Compass is a web-based application for Distribution Partners and Fund Providers, providing a collaborative fund information platform covering the Funds of Clearstream Fund Services. As a two-sided platform, Compass facilitates communication between the Distribution Partners and Fund Providers.

Compass enables access to the data relevant to the analysis, fund selection and full customisation of the distribution partner's investment funds universe (prices, share classes, performance, ratings, statistical data, fees, remunerations, registrations and others). Distribution partners benefit from a sophisticated fund search tool with various filters (for example: by EFC category, Risk, fund domicile) and can further refine their search with more than 50 static and dynamic selection criteria including performance, risk data and portfolio statistics. Furthermore, Compass introduces an innovative ESG Data solution in its search functionality, based on sustainability scores. With this service, CFCS supports distribution partners in their Client advisory process. On top of fund data, Compass provides access to a vast range of fund documents, including factsheets, prospectuses, KIIDs and many others.

Documents, static and dynamic data are constantly being updated and expanded in different languages.

The distribution experience is enhanced via the introduction of communication tools, such as the Blasts. Blasts enable Distribution Partners to directly interact with Fund Providers and ask for additional fund information and up-to-date documentation.

Compass Fund lists allow distribution partners to create tailored lists of investment funds from the fund universe available in Compass. Customised lists allow to cater to every investor profile based on share class, fund currency, domicile and risk.

New investment funds and/or share classes are continuously being added to the universe.

Clearstream Data Hub

Data Hub allows access to fund static and dynamic data, where available. The standard functionality also includes the possibility to download fund data and documents. Specifically, for fund data, distribution partners can download up to 250 static data fields.

With the standard module of Clearstream Data Hub, a user of a distribution partner has the permission to use the dynamic data internally. Such data are meant for personal use only. There is no permission to upload and share dynamic information within a team.

The "Enhanced" Clearstream Data Hub module allows distribution partners to upload the dynamic data and share it within their legal entity. However, the data cannot be used for external communications.

With the "Enhanced" functionality:

- The distribution partner can set up various data feeds (essentially unlimited);
- The distribution partner can access and download more than 600 data fields; and
- The data feeds can be set at either daily, weekly or monthly intervals.

The dynamic data consists of Morningstar data. Distribution partners can choose from the following Morningstar data: Risk & Performance, Portfolio Statistics, Full Data Bundle for either 10,000 or 50,000 share classes. Further customised dynamic data packages are available.

A modular feature is available, allowing an automated data transfer service to the IT infrastructure of the Distribution Partners via Secure File Transfer Protocol. The Enhanced functionality of the Clearstream Data Hub is a pre-requisite to access Clearstream SFTP.

With the SFTP functionality:

- The distribution partner has the same transfer options as with the "Enhanced" functionality;
- Can determine which data feeds should be set for SFTP delivery.

Data feeds are created overnight (CET time) and are not available immediately. Data feeds can also be accessed in Clearstream Distribution Platform directly and distribution partners are notified of data deliveries via email.

ISS ESG Solution

ISS ESG provides nine sustainability factors regarding the Environmental, Social and Governance (ESG) of investment funds.

By integrating these ESG datapoints, Clearstream aims to ease access to ESG information of investment funds to its fund distributors for fund selection, reporting and regulatory compliance.

Clearstream Product Expert and Service Explorer

Clearstream Product Expert and Clearstream Service Explorer are add-on service modules.

Clearstream Product Expert allows distribution partners to carry out regulatory and product-specific reviews. It enables distribution partners to obtain a list of eligible investment funds for a specifically defined client profile. All the rules and information, which distribution partners need to ensure that an investment fund is eligible for a specific client profile, are systematically integrated into the domestic and cross-border consultation framework on the basis of distribution partners' input (for example, CRM's domicile, client's domicile or client type). The review is done at ISIN level.

A free to use service is available in Compass to support the share class selection for specific client profiles based on the selling restrictions in the fund prospectus.

Clearstream Service Explorer is an extension of Product Expert. It allows the inclusion of individual rules by distribution partners. This service digitally captures and maintains the content of cross-border regulatory guidelines for a full range of banking services and, by doing so, supports distribution partners to meet compliance requirements for a wide variety of services. The cross-border activity review covers a check on the permission to carry out various activities.

For both services, Clearstream Expert and Service Explorer, the underlying rules can be supplied by the distribution partner or obtained from an independent provider via CFC.

Quantalys Easypack solution

The Quantalys Easypack solution is a front-to-back digital solution allowing Distributors domiciled in France, Italy, Luxembourg and Switzerland, to analyse market trends, select funds, create portfolios and execute investment decisions in a more efficient way.

The Easypack solution offers several features to assist in the selection of funds and the construction of portfolios.

- A simplified search engine, giving access to fund records allowing to filter on several fields.
- A fund comparator tool allowing the comparison of selected funds (up to 20) to indexes over the desired period.
- Basic financial indicators (performance, volatility, Sharpe).
- Quantalys proprietary data points (Quantalys fund ratings, Quantalys barometers).
- Fund factsheets.
- Document library (Prospectus, KIID, monthly factsheets).
- Basic fund by fund optimiser based on a quantitative pre-selection.
- Basic portfolio simulation and back-test, allowing the user to simulate and back-test a chosen portfolio of Investment Funds based on quantitative historic data.

- Distributors can access the Quantalys Easypack solution via a link on the CFS Portal.

Market Insights

Market Insights provides Fund Providers with user-friendly dashboards and detailed reporting, leveraging on Clearstream holdings and transactions. The tool offers:

1. A comprehensive overview of global funds industry trends.
2. Transparency regarding current and historical holdings and transactions within the distribution network.
3. Anonymised peer group data for comparing fund flows and holdings.

This page has intentionally been left blank.

4. Custody Business Operations - Fund Acceptance

CFCL provides Settlement and Custody, Transfer and Order Routing (Switch, Subscription and Redemption) services for Investment Funds.

4.1 Eligibility Assessment

The acceptance of Investment Funds in CFCL for either Settlement and Custody and/or Order Routing is subject to an Eligibility Assessment which is completed by CFCL Operational teams.

The CFCL Eligibility Assessment for Investment Funds shares is based on:

- CFCL governing documents and policies (subject to change at CFCL discretion);
- Approval from the Investment Fund or its Agents.

Fund Processing Group

Once the Eligibility Assessment is completed a Fund Processing Group (FPG) is assigned to the Investment Fund. The FPG indicates the level of eligibility (service) available for the Investment Fund.

The FPG is based exclusively on the Fund Characteristics as described in the Investment Fund Governing Documents (Prospectus) and cannot be amended based on Client preference.

There are four possible FPG's each indicating a different level of Eligibility. The Below table describes the varying Settlement and Custody and Order Routing availability per FPG. The FPG per ISIN can be viewed on the Published Funds List (PFL) available on the website.

Fund processing Group value on the PFL	Short Code	Available for Settlement and Custody	Available for Transfers	Available for Order Routing	Order Routing Service
Vestima	V	Y	Y see note on Transfer Restrictions	Y	Vestima Service
VestimaPRIME	VP	Y	Y	Y	VestimaPRIME Service
No Order Routing	CSO	Y	Y	N	Not applicable
CBL Ineligible	NQ	N	N	N	Not applicable

Further Details regarding the Vestima and VestimaPRIME Order Routing services can be found in [Chapter 5. Order Routing Services](#).

FPG Vestima: Transfer Restrictions

If the prospectus related to investment fund shares requires so, CFCL can restrict the transferability of investment fund shares within CFCL. This implies the involvement of the investment fund or its agents to control transfers between Clients. Rejection of these terms by the investment fund or its agents implies that CFCL cannot accept the impacted investment fund shares for settlement, custody and order routing.

The outcome of the Eligibility Assessment will result in one of the following statuses applied to the Investment Fund Shares:

1. **No Transfer Restrictions applied:** The investment fund share is freely transferable within CFCL;
2. **Transfer Restrictions applied:** The investment fund share has the transferability restricted within Clearstream Fund Centre, which implies the involvement of the investment fund or its agents to control transfers between Clients. Internal transfers between Clients may in certain cases be fully restricted within Clearstream Fund Centre which implies for a transfer a re-registration of the investment funds holdings via the fund shareholders/unitholders register (at the investment fund's discretion).

Reference Data

CFCL may collect and store Reference Data relating to the Investment Fund on a best effort basis as part of the Fund Eligibility Assessment in line with the CFCL governing documents and policies.

4.2 Client Suitability

Clients availing of CFCL's custody service have a responsibility to familiarise themselves with the relevant market investment guides and investor suitability policies available on the website.

CFCL does not monitor the compliance of its Clients with the prospectus or any other document supporting the investment fund, and such compliance is the sole responsibility of Clients using CFCL's Custody services.

This page has intentionally been left blank.

5. Order Routing Services

Clearstream Fund Centre S.A.'s order routing services are described in this chapter.

The provision of the order routing services by CFCL is subject to the order handling and record keeping requirements set out in Article 16 of Directive 2014/65/EU (MiFID).

5.1 Vestima order routing

Vestima order routing is CFCL's automated order routing service for the Investment Funds industry. It provides an entry and reception point for domestic, international and offshore funds, allowing orders and Order Confirmations to be submitted, validated and routed to the relevant recipient.

CFCL is operating two order routing platforms Vestima order routing and VestimaPRIME order routing. Vestima order routing provides a highly automated service aimed towards mutual funds, whereas VestimaPRIME order routing targets complex and alternative investment funds.

The decision for which Order Routing Platform to be used is based on the Fund Processing Group (FPG) of the Investment Fund. As part of the Fund Acceptance process CFCL will complete an Eligibility Assessment on each Investment Fund. As a result of this Eligibility Assessment the FPG value is calculated and assigned to the fund. The FPG is assigned based exclusively on the Fund Characteristics as described in the Investment Fund Governing Documents (Prospectus) and is not Client specific.

The assigned FPG for each Investment Fund can be viewed in the Fund Processing Column of the Published Fund List report accessible on the Clearstream Fund Centre S.A. website.

Further Details about the Eligibility Assessment and the different FPG values is available in [Chapter 4](#).

Unless stated otherwise, VestimaPRIME order routing is to be considered an integral part of the Vestima order routing services provided by CFCL.

Vestima order routing provides comprehensive services for routing and management of orders in Investment Fund Shares. Orders are received from an Order Issuer (OI - for example, distributor, custodian, asset manager). Order details are validated based on Standing Instructions and preferences, set by the OI. The orders are systematically forwarded by CFCL to CBL. CBL then forwards to the appointed third-party for execution, as CBL remains the owner of the accounts in the book of the OHAs.

OIs do not need to be concerned with the individual connectivity or order format of any OHA. Order Confirmations and other messages are received from the OHA and the order status can be tracked by the OI through status messages or in the CFS portal. Optionally, Settlement Instructions can be generated, based on Standing Instructions.

The CFS portal provides facilities for reporting, contingencies and enquiring on previously submitted orders, together with access to the Published Fund List.

Further details can be found on the website (for example, Vestima user guides and Published Fund List). The Published Fund List on the website specifies CFCL order cut-off times, which are typically zero or fifteen minutes prior to the Investment Fund's official cut-off times.

For orders routed through VestimaPRIME, the applicable CFCL order cut-off time is 90 minutes prior to the order cut-off specified in the fund prospectus. If no CFCL cut-off time is defined in the fund list, and the cut-off time specified in the fund prospectus is after the close of business on a particular day, orders should be received at least 30 minutes prior to close of business. In the event that a CFCL order cut-off time is after the cash deadline to execute a payment, the Client must respect the relevant cash deadline when placing the order. For this purpose, close of business shall be 18:00 CET on any Business Day. CFCL guarantees that all orders received before the CFCL cut-off time will be made

available to the OHA before the fund cut-off time. Valid orders are forwarded promptly to the OHA, independently of the CFCL cut-off time.

Prior to placing a subscription order, when there is no current holding on the OI's account of the particular Investment Fund, the OI must contact CFCL to ensure the Investment Fund's availability to the OI for order routing through CFCL. For orders placed in a particular fund investment in VestimaPRIME order routing, where the account is neither open nor active, the 90 minutes prior to the order cut-off is not applicable.

If an Investment funds position was acquired via internal transfer with another CBL account, OI's must before placing any redemption or switch order ensure that all setups are in place with the OHA for a proper execution of the redemption or switch order. This also applies to reception of funds, received as a result of a Fund Linked Notes redemption.

Prior to the acceptance of a new share class (for example, bonus shares, side pockets) to existing OIs, CFCL may have to obtain information from the OI.

In either of these above two cases, if the setup of the Investment Fund's availability requires that the OI shall provide CFCL with pertinent documentation (such as private placement memorandum, subscription agreement or completed questionnaire), CFCL shall notify the OI who must respond without undue delay and within any applicable deadline. The OI agrees to hold CFCL harmless of the OI's failure to respect any such given deadline.

Depending on the fund, Transfer agents/OHAs might require time to setup a new relationship/reference in their environment. In such cases, the OI should give sufficient notice to CFCL, and await confirmation that the relevant and requested setup is ready, before placing the initial transaction in a particular Investment Fund. When OI eligibility rules are imposed by the OR, CFCL will request additional information from the OI. Failure by the OI to comply will result in no liability to CFCL, should the Investment Fund impose penalties, forced redemption, exchange of the position or other remedy.

CFCL may provide order routing Dividend reinvestment service for Investment Funds in scope, whenever possible and upon receipt of a specific standing instruction from the OI, to enable OIs to instruct CFCL to reinvest any cash Dividend proceeds into new Investment Funds Shares. The transactions will be settled in the CFCL account at the price applied by the Investment Fund. If the reinvestment cannot be performed at the date specified by the Fund in the Corporate Action Notification (due to a late notification) the reinvestment will be performed as soon as possible on the basis of the next available NAV. A notification must be received at least 90 minutes before the cut-off to be processed. Upon receipt of the new shares from the Investment Fund, CFCL will credit the shares to the OI's designated account for Dividend reinvestment. If the Investment Fund does not accept reinvestment orders, the cash proceeds remain credited to the OI. OIs can request the addition or amendment of a standing instruction by sending a dedicated Instruction to CFCL via an authenticated message.

CFCL's provision of the order routing Dividend reinvestment service is dependent on the service level provided by the Investment Fund and is subject to a feasibility assessment by CFCL on a case-by-case basis.

Connecting accounts to Vestima order routing services

Clients can use their existing custody accounts with CBL for Vestima and VestimaPRIME to perform order routing of mutual funds and alternative funds.

To connect to Vestima or to VestimaPRIME and Vestima, the client is required to complete the CFCL Client Application Form and Vestima Service Application form. That must be completed in original form and returned by mail to order routing services from CFCL.

Order routing and order management service conditions

In providing order routing services, CFCL acts in the name and on behalf of the OI in forwarding the order and certifications to the account owner, CBL, which forwards them to the OHA, including any

addendum, supplement, restatement and/or applicable replacement, on the OI's behalf, informing the OHA that the OI is the responsible party. Order status reports and Order Confirmations received from an OHA in reply to a forwarded order, are delivered to the OI.

Unless expressly stated otherwise, CFCL is only responsible for the order routing services consisting of the transmission details of the Transaction for the CFCL account of the Client, statement or any other information provided, and CFCL does not become party to the buying or selling of the Investment Fund Shares detailed in the Transaction, statement or any other information provided; the OIs and the OHAs are responsible for the content of the information exchanged between them.

Subject to the conditions described in the previous section, Vestima order routing populates data relating to trading parties as may be required by the relevant OHA. The OI is responsible for contacting CFCL for all trading parties reference data maintenance requirements.

CFCL shall not be liable for the failure of the OI to provide any certification that may need to be sent directly to the OR, nor for any consequences of the OI's delay or errors in providing any certification. If appointed by the OI to provide certification to an OHA, CFCL will promptly transmit the certification but shall not be responsible either for the consequences or for the accuracy of the certification.

Fund Reference Data is provided for information purposes only and does not replace the Investment Fund's governing documentation. CFCL does not guarantee the completeness, accuracy or authenticity of Fund Reference Data.

For Primary Market Orders, CFCL will route all Clients orders to CBL for execution, as CBL remains the entity routing orders to OHAs.

Order routing services for some markets require specific documentation. For further information, please contact CFCL.

Where French market orders are sent manually directly to a French OHA, CFCL will follow the "Charte des Bonnes Pratiques Professionnelles de la Centralisation d'OPCVM" of the Association Française des Professionnels des Titres (AFTI), without prejudice to compliance with CFCL Governing Documents. For orders that require a telephone call to the OHA, the OI will incur an additional charge in accordance with the existing Clearstream Fund Centre S.A. Fee Schedule.

CFCL will select the most appropriate method to send the orders to the OHAs, depending on the operational requirements of each individual OHA. The service that CFCL can provide depends on the rules and practices of the relevant market or Investment Fund and on the OHA and, therefore, may vary across all the Investment Fund Shares eligible for CFCL order routing.

For an increased level of automation, CFCL can generate Settlement Instructions on the Client's behalf for the Settlement of Transactions in Investment Funds in an account with CFCL. Transactions that have settled using Settlement Instructions generated by CFCL can be reversed or amended by CFCL.

All Investment Fund Orders sent to CFCL must be sent via Vestima order routing. Any order received that is not transmitted to CFCL via Vestima order routing (for example, via free-format message) is handled at the discretion of the Investment Fund Order Routing Desk and on a "best efforts" basis only. CFCL reserves its right to reject any non-Vestima order and may require the OI to transmit the order via Vestima order routing instead.

Electronic certificates are provided by CFCL to allow encrypted access to Vestima order routing via CFS Portal. Participants shall exercise due care in the safeguarding of their electronic certificates and associated authentication credentials. CFCL gives no assurance or warranty with regard to the security of any communication performed using electronic certificates.

Considering the service mandate offered by CFCL to its Clients, limited to the routing and transmission of orders as defined by Directive 2014/65/EU, the investment decision is taken solely by the Client and CFCL is only in charge of the transmission of the Client's order instructions. In line with Article 25 of Directive 2014/65/EU, CFCL is not required to perform an assessment of the suitability and appropriateness of the investment services it offers to its Clients. For this reason, investment risk factors should be evaluated by the Clients, who, in case of doubt, are invited to consult their professional advisers. CFCL is under no circumstance taking an investment decision nor acting as an

investment advisor and shall therefore not bear any liability with respect to the risks inherent to the investment and/or any other transaction in relation to investment funds.

Additional service conditions

Where the Client has granted CFCL with a PoA to access the account held at CFCL and to instruct CFCL to debit the account for the purposes set out therein, CFCL reserves the right at its own discretion to take one or more of the following actions as needed to forward orders and process subsequent Settlement:

- Debit cash from the CFCL account of the OI on the Requested Settlement Date of a subscription/buy order as determined by the OHA. For a subscription/buy order that the OHA requires to be prepaid, CFCL reserves the right to debit cash from the CFCL account of the OI when forwarding the order to the OHA;
- CFCL does not undertake to check whether sufficient cash or Collateral is available on the CFCL account when forwarding a subscription/buy order;
- Check whether sufficient Investment Fund Shares are available on the CFCL account of the OI before forwarding a redemption/sell order (provision check). In the event of an insufficiency, CFCL can reject the redemption/sell order; This provision check will also apply in primary market where there is a Delivery Free of Payment instruction and insufficient positions;
- Block the relevant position of a redemption/sell order by transferring, when the order is processed by CFCL, the Investment Fund Shares from the CFCL account of the OI.

In forwarding orders, CFCL acts in the name and on behalf of the OI and holds the OI responsible for ensuring timely and correct Settlement, including in particular:

- For subscription/buy orders, ensuring that sufficient cash or prearranged credit facilities are available:
 - Many Investment Funds require value day cash payments of subscriptions, and the deadline for provisioning of the Clearstream cash account is as per the cash deadline of CFCL;
 - Subscriptions in some Investment Funds require intraday cash payments to have reached the collection account of the fund at a specific time of the day. CFCL will, in such cases, need to debit the OI's CFCL cash account at an earlier time of day. The OI shall ensure sufficient cash is available for such intraday cash subscriptions not later than 08:00 CET.
- For redemption/sell orders, ensuring that Settlement proceeds are in line with the fund prospectus or as determined by the OHA. The redeemed Investment Fund Shares shall be available for delivery to the OHA;
- The OI is solely liable for the payment of any accrued performance or incentive fees due on the redeemed Investment Fund Shares.

If the OI fails to meet its Settlement obligations, CFCL:

- May seek redress from the OI for any loss, claim, liability, damages or expenses that arise from the credit or debit to the relevant account in the Investment Fund Register subsequent to an order;
- Is authorised, at any time between confirmation of the order and Settlement, to purchase from the OHA the Investment Fund Shares required to settle a redemption/sell order and to debit accordingly the Clearstream account of the OI. CFCL will advise the OI as soon as practically possible before such debit occurs.

By sending an Investment Fund Order, the OI warrants and accepts that:

- It has full legal capacity to issue orders for Investment Fund Shares;
- It complies with applicable laws and regulations, including but not limited to the laws regarding the prevention and prosecution of money laundering and terrorist financing;
- It complies and shall comply with the terms and conditions of the relevant Investment Funds;

- It does not, unless otherwise disclosed by the OI to CFCL before sending any order, act as an investor within the meaning of the UCITS Directive¹ and the Commission Regulation 583/2010². If CFCL is notified by an OI that it is acting as an investor, CFCL will then advise the relevant OHA accordingly;
- CFCL shall receive orders from the OI by a means of communication agreed upon with the OI and shall forward them CBL on behalf and in the name of the OI;
- CFCL shall check whether the mandatory information on orders is provided and may reject all incomplete or incorrect orders. In doing so, CFCL shall check only the format of the orders;
- CFCL shall handle otherwise comparable OI's orders sequentially and promptly, in line with the requirements set forth by Directive 2014/65/EU;
- CFCL does not guarantee that orders received after the CFCL cut-off time shall meet the Investment Fund's deadline for orders;
- If a prospectus of an investment fund allows multiple NAV currencies for a particular share class and if due to technical or operational reasons the multiple NAV currencies cannot be adequately supported by CFCL, CFCL may at its discretion only accept the base currency for such class in the order routing process. In this context, should the OI still require a subscription order to be sent in a NAV currency that is not the base currency for that class, the OI needs to send that order directly to the OHA in its own name without any involvement of CFCL (that is, such a position will not be reflected on the OI account in CFCL). In the event of a redemption or switch to order, only the base currency will be accepted within CFCL. For a redemption or switch to order in a NAV currency different than the base currency, the OI needs to contact the OHA to organise first a transfer out to or open an account on their own name in the Register before proceeding with such order;
- As soon as an order is transmitted to the OHA by CBL, this is considered as irrevocable. CFCL accepts cancellation requests and processes them on a "best efforts" basis only, and CFCL does not guarantee that ORs will accept cancellation requests regardless of the time such requests are sent;
- For redemption/sell orders, where applicable, if the OI requests a specific lot be redeemed, the original trade date and trade reference must be included in the OI's order. CFCL forwards this information to the OHA, and whether the information is specified or not the OI's shares will be redeemed as per the rules of the OHA;
- For all redemption orders processed by VestimaPRIME, where partial payments are made, CFCL will provide a partial redemption advice to the OI indicating the percentage of redemption proceeds paid and the estimated price;
- For all orders processed by VestimaPRIME, Clients who wish to buy or receive Investment Fund Shares that generate U.S. sourced income will be required to identify the relevant U.S. tax treaty pool.

Furthermore, for order instructions in Securities with staggered payment structures:

- In instructing CFCL to purchase Investment Fund shares with staggered payment structures, the OI agrees to authorise CFCL to debit the OI's CFCL account for the amount required to be paid in connection with the purchase and/or for any future amount(s) required to be paid in relation to any capital call/commitments, or any other requirements as required by such shares. The OI shall deposit sufficient funds in its account. If the OI does not have sufficient funds in its account to cover any capital calls or other requirements, CFCL shall be under no obligation to fund future capital calls or other requirements for the OI's account;

1. Directive 2009/65/EC of the European Parliament and of the Council of 13 July 2009 on the coordination of laws, regulations and administrative provisions relating to Undertakings for Collective Investment in Transferable Securities (UCITS).
 2. Commission Regulation (EU) No 583/2010 of 1 July 2010 implementing Directive 2009/65/EC of the European Parliament and of the Council as regards key investor information and conditions to be met when providing key investor information or the prospectus in a durable medium other than paper or by means of a website.

- The investment is made exclusively for and by the OI and CFCL shall not have any obligation or responsibility in connection with the investments that are made, including, without limitation, any responsibility to respond to, or provide capital in connection with any capital calls or other requirements as set out in such Investment Funds offering documents, subscription agreements or limited partnership agreements. CFCL will inform the Investment Fund or its agent that the Client is the responsible party and that CFCL only acts in a processing capacity;
- The Client undertakes to indemnify, defend, reimburse, and hold CFCL, their affiliates, officers directors and employees (collectively the "Indemnified Parties") harmless for, from and against any loss, liability, cost, damages, expenses (including legal fees taxes and penalties) or other amounts which may result directly or indirectly from or in connection with (i) any misrepresentation or breach of any warranty, condition, covenant or agreement set forth in the relevant subscription agreement (or equivalent document(s)), or (ii) any other document delivered by CFCL to the Investment Fund issuer or its agent in connection with the Client's order instruction.

Note: CFCL is not doing any cash provision check on Clients' accounts to verify that sufficient cash is available. Therefore, the above section applies under assumption that the Client has sufficient funds available on the account.

This page has intentionally been left blank.

6. Settlement Services

CFCL is exclusively using Clearstream Banking Luxembourg (CBL) as sub-custodian.

All settlement instructions received from CFCL Clients are first processed and checked by CFCL and then reflected in Clearstream Banking Luxembourg.

Once instructions reach the sub-custodian's settlement system, the standard deadlines, matching and provisioning processes of the custodian apply.

6.1 Types of Settlement instructions

Settlement instructions instructed by CFCL Clients can be split into two categories:

- **Order-based settlement instructions:** Settlement instructions generated following an order placed on Vestima order routing or Vestima Prime order routing;
- **Non order-based settlement instructions:** Settlement instructions generated without order on Vestima order routing or Vestima Prime order routing.

Order-based settlement instructions

CFCL Clients receive the settlement details of the counterparty to the transaction in the order confirmation received from Vestima order routing or VestimaPRIME order routing (that is, place of settlement, the receiving or delivering agent, ...).

Depending on the types of links CFCL has for each fund, the counterparty of the instruction can be another CFCL Clients, a CBL Client or a domestic counterparty (for domestic markets). Clients are responsible for formatting their instruction adequately. Information on settlement specificities per market is available on the website.

CFCL Clients can also subscribe to the automated settlement service, whereby settlement instructions are automatically generated at order confirmation.

Non order-based settlement instructions

When a fund is not subject to settlement restrictions, CFCL Clients can exchange fund shares with standard settlement instructions (DVP and FOP settlement) with eligible counterparties.

For CFF funds and funds issued via a common depository structure, eligible counterparties are any Clients with a CFCL or a CBL account.

For funds issued through domestic markets, the fund shares can be exchanged with any CFCL, CBL or domestic counterparties.

ETFs and closed ended funds can also be exchanged with Euroclear counterparties, via a specific settlement mechanism between CFCL custodian (CBL) and Euroclear ICSD. Please refer to the ETF settlement guide for more information.

Funds with settlement restrictions can only be exchanged through external transfers. CFCL Clients can generally place settlement instructions against a generic counterparty (FMA01) and populate the buyer/seller field with the SSI's of the counterparty (that is, name and address or BIC code, as well as its register account number at the Transfer Agent). CFCL will then generate an external transfer as per the fund guidelines.

CFCL only accepts to process transactions with Euroclear for securities eligible for admission in both CBL's and Euroclear's systems. Transactions with Euroclear can be settled in the CBL securities

settlement system either free of payment or against payment in any eligible currency, as described on the website.

6.2 Instruction deadlines

CFCL may decide to send settlement instructions received from its Clients directly to the custodian or to apply some internal validation rules before sending them to the custodian.

If instructions are correctly formatted, instructions are sent immediately to the sub-custodian settlement system.

The settlement deadlines and settlement timing depend on the counterparty and the market link for the fund traded. CFCL strictly applies the deadlines provided by the custodian. More information on the settlement deadlines can be found on the website.

By default, all CFCL settlement instructions are eligible until the end of the settlement day, regardless of the cash deadline of the settlement currency. CFCL Clients have the possibility to restrict the settlement eligibility of instructions according to the mandatory or optional deadlines per currency.

The settlement day is split into two settlement periods, for internal and instructions with Euroclear:

- The mandatory settlement period, during which a delivery may only be refused for reason of cash or credit provision (or, temporarily, for risk management purposes);
- The optional settlement period during which Clients may determine eligibility for settlement by means of an optional settlement flag (OSF).

The optional settlement period follows the mandatory settlement period for against payment instructions only and, provided that Clients have determined that their instructions are to be eligible for the optional settlement period, all internal and Euroclear instructions against payment instructions unsettled at the end of the mandatory settlement period and any new or amended against payment instructions received by the respective input deadlines for optional settlement, are processed in the optional settlement period.

Mandatory settlement period

	Receipts		Deliveries	
	Free of Payment	Against Payment	Free of Payment	Against Payment
Internal				
for mandatory settlement only (in all currencies except ARS, CAD, GBP, MXN, PEN and USD)		16:00 SD		16:00 SD
for mandatory settlement only (in ARS, CAD, GBP, MXN, PEN and USD)		18:00 SD		18:00 SD
for mandatory settlement	20:00 SD		20:00 SD	
for optional settlement		20:00 SD		20:00 SD
Bridge				
for mandatory settlement only (in all currencies except ARS, CAD, EUR, GBP, MXN, PEN and USD)		13:50 SD		13:50 SD
for mandatory settlement only (in EUR and GBP)		15:20 SD		15:20 SD
for mandatory settlement only (in ARS ^a , CAD, MXN, PEN and USD)		17:00 SD		17:00 SD
for mandatory settlement	18:30 SD		18:30 SD	
for optional settlement		18:30 SD		18:30 SD
Securities credit/debit	SD	SD	SD	SD
Cash credit/debit	/	SD	/	SD
Cash value date	/	SD	/	SD

- a. Although the input deadline for all Bridge instructions against payment ARS is 17:00, clients are recommended to send their receipt instructions against payment in ARS by 15:30 at the latest. Both counterparties must ensure the receipt and the delivery instructions are for the mandatory and optional settlement periods.

Figure 6.1 Internal and Euroclear instructions

To be noted that if the issuer or counterparty of an instruction opted for this settlement period restriction feature, the instruction is only eligible for settlement until the cash deadline is reached, the Settlement Matrix is available on the the website. Information on the cash deadline is available in the Cash Timings Matrix, on the website.

6.3 Instruction format

Swift and ISO message standards that are applicable to our business environment are supported and used in industry-standard ways. ISO 15022 represents one of the standards that has been built and adopted by the securities industry to enable higher straight-through processing rates and engender better efficiency.

When formatting settlement instructions, CFCL Clients and their counterparties should always mention CEDE/account number when identifying a CFCL Client accounts in any of the settlement parties (DEAG, REAG, BUYR, RECU).

6.4 Provision checks

CFCL may decide to perform provision checks before releasing an instruction to its custodian or to delegate the provision check to the custodian.

Cash or securities provision check

Securities provision must be available on the relevant account position. Cash provision must be available either on the account or through credit facilities. It is the Client's responsibility to ensure the timely availability of securities and cash provision, as appropriate.

Collateral provision check

The collateral provision check, under Credit and Collateral services in agreement and granted by CFCL, ensures that after the instruction has been executed, sufficient collateral to cover outstanding obligations will still be available on the account.

Instructions that do not satisfy these provision checks remain unsettled and appear in the suspense provision section of the MT537 (Statement of Pending Transactions).

6.5 Settlement sequence

As illustrated in [Figure 6.2](#) below, once an instruction is ready for settlement (matched and released), the order in which Transactions are considered for provisioning and settlement is determined by:

- The Transaction priority (assigned by the Client or by CFCL);
- The Settlement Sequence Option on the account.

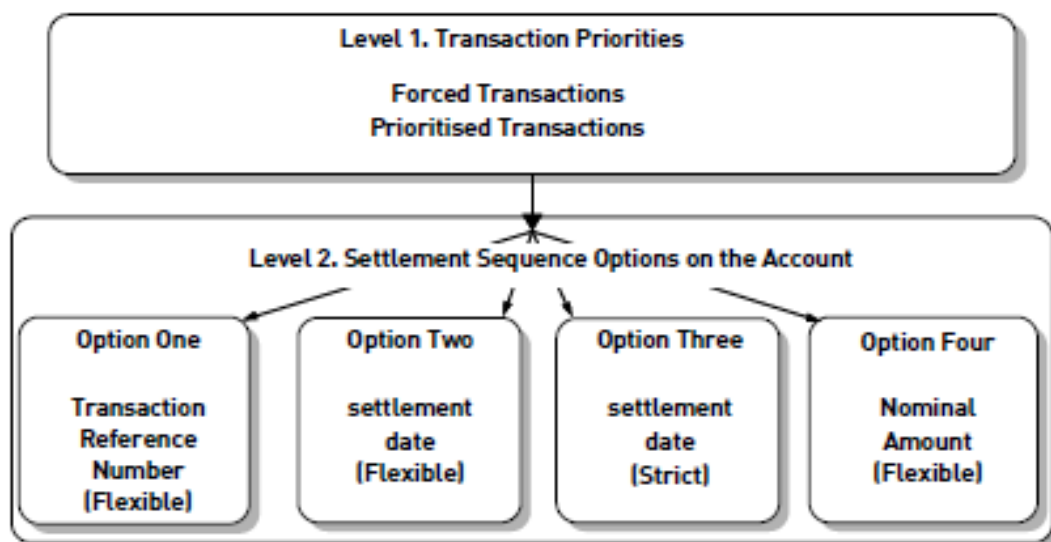

Figure 6.2 Transaction priorities and Settlement Sequence Options

Priority can be assigned to transactions by CFCL (in the case of forced Transactions), or it can be allocated by the Client, using a Priority Code input on the instruction.

Note: A Client cannot assign a Priority Code on cash instructions (MT103, MT202, MT210). Cash on the account will be used first to provision securities purchases to maximise settlement efficiency, provided that the securities instruction fulfils the conditions to settle.

Clients specify the Settlement Sequence Option when an account is opened; they can change it subsequently if required. The option specified applies only to transactions for delivery of securities.

Level 1. Transaction priorities

Forced transactions

CFCL may "force" transactions such as:

- Fund payments, where settlement has already occurred and the account is to be updated;
- Primary market transactions, where funds have been released through the lead manager;
- Fees and charges due on the account.

Forced transactions always have the highest priority.

Prioritised transactions

Clients can prioritise both deliveries (to control settlement in a specified security code) and receipts (to control the use of funds). Full details of how to prioritise transactions are given in the communications user manuals.

The priority code gives one transaction priority over other instructions ready for settlement on the same account and in the same security or currency. Clients can prioritise a securities transaction when the instruction is first sent to CFCL.

It is possible to add priority to pending instructions, but this will depend on the transaction type and on the stage the instruction is at in its life cycle, as follows:

- If it is an internal Transaction, priority can be added at any stage;
- If it is other than an internal Transaction:
 - If the instruction has been processed at least once and as a result appears in an MT537 (Statement of Pending Transactions), priority can be added at this stage, unless the instruction is already provisioned.
 - If the instruction has been sent but not yet processed, the Client is obliged to cancel the instruction and send a new one, specifying a priority code, under a new transaction number.

The priority code takes effect when the transaction reaches the processing for the requested settlement date and if all matching requirements for settlement are satisfied. The priority code is most effective on deliveries of securities, free or against payment. Provision is reserved to settle the highest priority transaction. Once reserved, this provision cannot be used to settle any other instruction as long as the highest priority transaction is still eligible for settlement.

During real-time settlement and end of day processing, not all instructions are permanently presented for settlement as not all are continuously eligible. Eligibility for settlement and provision depend on the following:

- The settlement period: mandatory or optional;
- The processing timings of domestic markets.

Only prioritised instructions eligible for settlement can be prioritised according to the Client's settlement sequence. Since the eligibility of Client instructions has an impact on the Client settlement sequence, Clients should consider the above when inputting their instructions. Additionally, transaction

linking and hold/release functionalities are available to further secure the transaction settlement sequence.

A priority code can also be input on an against payment receipt Internal instruction and a settlement with Euroclear receipt instruction (MT541 instruction) to determine which transaction will settle first if funds are insufficient to settle all transactions, but the priority handling of receipt instructions cannot be guaranteed in all instances as it can be overridden by the priority treatment of deliveries. Furthermore, it can only take effect if the counterparty presents the securities for settlement. If the counterparty of a prioritised receipt instruction is not able to propose its delivery, other purchases/receipts in the same currency can nonetheless be settled.

In the event that there are insufficient funds to settle all eligible receipt transactions for a given security, the rules applied after considering the priority of instructions take the instruction with the largest countervalue first. In case of identical countervalues, the instruction with the lowest Client reference number is settled first.

Note: A priority code cannot be input by the Client on cash instructions (MT210, MT103 or MT202).

Level 2. Settlement Sequence Options on the account

The account Settlement Sequence Option determines the order in which transactions with the same priority are queued by CFCL for provisioning. With the exception of option three, settlement sequences are Flexible, meaning that:

- If a transaction higher in the queue cannot be settled with the provision available, then transactions lower down the queue will be settled (if sufficient provision is available);
- Provision will not be reserved for a transaction that does not settle.

During the mandatory settlement period, the process is repeated several times. Transactions already settled cannot be unwound; therefore, at each stage, only those transactions that have previously failed to settle are re-queued for provisioning and settlement. Deliveries are ordered as follows:

Option one: Transaction Reference Number (Flexible)

This is the "default" Settlement Sequence Option applied to Client accounts if no request is made by the Client. It can be summarised as follows:

First: Transactions that are two days or more past the requested settlement date are provisioned in the following order:

- Transaction reference number (lowest number first);
- Nominal amount (largest first) if the same reference number is used.

The same reference number can be used if the information in one or more of the following fields is different from that in an instruction that has already been received for processing or that is in the MT537 (Statement of Pending Transactions): Instruction Type, Instructing Party's Account Number, Counterparty's Account Number, Security Code, Nominal.

Second: Transactions for the settlement date of the processing and the previous settlement date are considered for settlement in the same sequence as above.

Option two: Settlement date (Flexible)

Transactions are considered for settlement in the following order:

- First:** Requested settlement date (oldest first);
- Second:** Nominal Amount (largest first);
- Third:** Transaction reference number (lowest number first).

Option three: Settlement date (Strict)

Transactions are provisioned for settlement in the same sequence as in option two, above, except that the first criterion (Requested settlement Date) is applied strictly. This means that, within the same priority, Provision will be reserved for instructions with the oldest settlement Date first, for as long as the instruction is eligible to settle. Transactions will be provisioned for settlement, in the following order:

- First:** Requested settlement date (oldest first, Strict);
- Second:** Nominal Amount (largest first);
- Third:** Transaction reference number (lowest number first).

Option four: Nominal Amount (Flexible)

Transactions are considered for settlement according to the following criteria:

- First:** Nominal Amount (largest first);
- Second:** Requested settlement date (oldest first);
- Third:** Transaction reference number (lowest number first).

6.6 Matching requirements

Instructions with a counterparty in CFCL, CBL or Euroclear ICSD are subject to mandatory matching in CFCL. Matching information is available to Clients by means of pending transaction reports MT537 (Statement of Pending Transactions) and MT548 (Settlement Status and Processing Advice).

Matching should occur as soon as possible after a transaction is arranged to detect differences or errors in the instructions submitted by the two counterparties.

For instructions with domestic counterparties, domestic rules on mandatory matching apply. Additional information can be found in each market guide on the website.

Fields used for first layer matching

First layer matching is performed on the details of the trade and on the settlement location of the two parties or their agents.

Transaction type

Receipts and deliveries are matched according to the transaction type. For example, an MT541 Receipt Against Payment Internal instruction is matched with an MT543 Delivery Against Payment Internal instruction. This rule does also apply to instructions with counterparties in domestic market or in Euroclear ICSD where matching is required.

Account number

Each counterparty must specify the account number to which delivery of securities or payment of funds is to be made. When identifying a CFCL account number, CFCL Clients and their counterparties must instruct using CEDE/account number.

Requested settlement date

Matching of the requested settlement date confirms the value (in terms of funds) or availability (in terms of securities) to which both parties agree.

Security code

Both counterparties must agree as to the security in which they have traded and on the market for the relevant place of safekeeping. Each security is identified by its common code or ISIN. Where the same security is held in more than one position on an account, the place of safekeeping and ISIN, or common code must be provided to identify the relevant account position.

Nominal Amount

Each counterparty must agree the amount of securities to be delivered on each transaction.

ISO currency code and Countervalue

The ISO currency code and countervalue are a matching element for against payment transactions. The exact requirements are as follows:

Transactions in EUR

For all instructions with a CBL, CFCL or Euroclear counterparty against payment in EUR, the following cash tolerance levels apply:

- EUR 2 for transactions of an amount up to or equal to EUR 100,000;
- EUR 25 for transactions of an amount greater than EUR 100,000.

For instructions against payment in non-Euro currencies, the following cash tolerance levels apply:

- EUR 2 equivalent for transactions of an amount up to or equal to EUR 100,000 equivalent;
- EUR 25 equivalent for transactions of an amount greater than EUR 100,000 equivalent.

When the instruction is processed for settlement, the transaction settles with the countervalue instructed by the seller.

A currency and countervalue can be given for information purposes only in free of payment instructions (MT540 and MT542) with internal and Euroclear counterparties. Such information is not used for settlement matching.

In the case of against payment instructions with a domestic counterparty, the maximum discrepancy tolerated in settlement matching varies in accordance with market practice and the conditions of the domestic link. Details are given in the Market Link Guide.

Trade information

Trade information consists of three fields:

- Trade Date: mandatory field;
- Trade Price: the actual price of the securities as agreed by the two trading parties at the time of the trade;
- Special instructions Code: indicating delivery status.

Trade date and price matching

The Trade Date is a mandatory field for all settlement instructions.

The Trade Price is an optional matching field. Any discrepancy - except in the sixth decimal place of the Trade Price - will result in the instruction remaining unmatched.

6.7 Settlement report

Real time processing and reports

Real-time processing reports include MT536 (Statement of Transactions), MT537 (Statement of Pending Transactions), MT548 (Settlement Status and Processing Advice) and the MT578 (Settlement Allegements). These reports are generated intraday, while delta reporting of MT537 is also generated on a continuous basis. The status codes include the transaction status "Settled" to indicate that a Transaction has settled during real-time processing. Free of payment entries of securities are also reported.

End of day processing and reports

During the final end of day processing, any remaining internal pending transactions authorised for optional settlement are processed.

Automatically generated end of day reports will be made available at 21:15 SD. Please refer to [Chapter 10. Reports and information services](#).

6.8 Interest claims

CFCL adopts the ICMA Recommendation to its Rule 406. As a consequence:

- No claim shall be considered for amounts of less than USD 100 or its equivalent in another currency;
- No claim shall be considered after a lapse of thirty calendar days from the date on which the Transaction was actually settled.

These guidelines apply to all CFCL Clients and Transactions processed in all securities accepted in CFCL.

6.9 Short selling

Short selling of income or corporate action proceeds is not authorised for settlement in CFCL. Accordingly, CFCL reserves its discretionary right not to settle any instruction related to such short selling.

If a short selling transaction is or has been nevertheless settled by CFCL, the seller authorises CFCL to debit its account in CFCL for an amount equivalent to the gross income or gross corporate action proceeds.

In addition, the seller shall indemnify CFCL against all liabilities, damages, losses, or any claims that CFCL might incur in case other CFCL Client(s) or any other third party have either been deprived due to the short selling from all or part of their entitlement to tax reclaims (if any) linked to the income or corporate action proceeds received by such CFCL Client(s) in respect of the securities of the same description as the ones in which the short selling transaction occurred, or have suffered any other loss, damages, costs or claims due to the short selling.

More generally, the seller shall be responsible for all the consequences of the short selling on the tax treatment of the tax reclaims under the relevant tax regime.

Please refer to [Chapter 8. Asset Servicing](#).

6.10 Hold/Release mechanism for securities settlement instructions

The Hold/Release mechanism enables clients to temporarily hold back a securities transaction from settlement, even if cash or securities provision is available, and to release it only when settlement is desired.

The service is available for internal, Bridge and external instructions, free of payment or against payment.

The "Hold" condition can be specified immediately when sending instructions to CFCL or, provided that the instructions are still pending in CFCL, it can be added at a later stage.

The "hold flag" on a Pending instruction can be removed by the emitter of the instruction. Instruction matching is unaffected by the Hold/Release functionality. Once released, the instruction follows the normal settlement pattern.

Reporting

Reporting is adapted to reflect the impact on the status of instructions on hold as follows:

- Status BOTH is reported when the two matching instructions are on hold.
- Status PREA is reported when the emitter's instruction is on hold and its counterparty's instruction is released.
- Status PRCY is reported when the counterparty has instructed an instruction "On Hold" and the emitter has entered a released instruction.

The reporting of on hold instructions will be done at any time (even before the requested settlement date) for both matched and unmatched instructions.

Restrictions

An instruction cannot be held back from settlement in the following instances:

- The instruction to be put on hold is "locked-in" for settlement or provisioned and released to the domestic market. Instructions that had been transmitted to a settlement location external (Domestic CSD) to CFCL custodian CBL cannot be put on hold, even if the actual domestic settlement has not yet taken place.
- The instruction has reached an end of life state.
- The instruction is part of a "Domestic Back to Back pool". These different pool types cannot be commingled with "Hold/Release" regardless of whether a pool status is complete or incomplete. If an instruction contains both "Domestic Back to Back" information and "Hold" information, the "Hold" information will be rejected. A modification request to add a Hold flag to an instruction that is participating in such a "Pool" will be rejected and an error message generated.
- Cash and "for Matching only" instructions cannot be put on hold.

The "Hold/Release" mechanism can be used in combination with the Transaction Linking Service but the following must be considered:

- Transaction linking automatically puts the contingent instruction(s) on hold until settlement of the linked instruction(s) is achieved. Hence contingent instructions that are pending cannot be put on hold as they have this status already.
- Placing a linked instruction on hold means that contingent instructions cannot settle until the linked transaction upon which their settlement depends has been released and settled.
- Releasing an instruction that is contingent on the settlement of a linked transaction results in the link being broken for that instruction and it is released for normal settlement.

Impact on other functionality

Immediate Release flag: The "Hold flag" takes precedence over the "Immediate release flag" in case the two flags are present in the same instruction. The instruction will not be released for settlement processing until the client releases the instruction. **Priorities:** The "Hold flag" overrides any priority setting for the provisioning of the instruction on hold. Priority will take effect only when the instruction is released for settlement.

6.11 Partial settlement for internal and Euroclear instructions

Partial settlement

Partial settlement consists in the settlement of one unique transaction in several phases until the full settlement of the original quantity or the cancellation of the remaining outstanding quantity. Each time part of the original quantity has been settled, the effective settlement is reported to clients specifying the quantity of securities effectively settled, the quantity of securities previously settled (if any), and the quantity of securities remaining to be settled.

Partial settlement is triggered in the case of a lack of securities on the delivering client's account.

Partial settlement is not triggered in the case of a lack of cash on the receiving side.

There may be multiple partial settlements for a given instruction on the same processing day and/or over multiple processing days.

Instructions subject to partial settlement

Free of payment and against payment internal and Bridge transactions are eligible for partial settlement.

Partial settlement timing

Fixed partial settlement windows

Partial settlement takes place in four windows for Bridge settlement and in eight windows for internal settlement.

Partial settlement time windows:

No.	Time window (CET)	Transaction type
1	Around 22:30 on SD-1 (start of the day)	Internal settlement only
2	Around 06:05 on SD	Internal settlement only
3	Around 07:05 on SD	Internal settlement only
4	From 13:40 to 14:25	Internal and Bridge settlement
5	From 15:10 to 15:55	Internal and Bridge settlement
6	From 16:40 to 17:35	Internal and Bridge settlement
7	From 18:20 to 19:05	Internal and Bridge settlement
8	Around 20:00 on SD (end of the day)	Internal settlement only

The above table only provides an estimation by when the partial settlement will be attempted. An instruction can only be partially settled if the instruction is still eligible for settlement on that day.

Account setup: Default value for partial settlement

The partial settlement indicator is set up at the client account level with two values (PART = partial settlement is applicable, and NPAR = partial settlement is not applicable). The default value at account level is "NPAR", meaning that by default partial settlement is not applicable to all settlement instructions. This indicator can be modified at any time by the account owner.

To change the account setup (to opt-in), the account owner must contact Clearstream by sending either an authenticated MT599 message via Swift, CFS Portal or a letter to CFCL with authorised signatures to the attention of Account Administration Luxembourg.

Partial settlement at the level of the instruction

The default setup at account level for a particular instruction can be changed. The input of a partial settlement indicator at instruction level is possible. The partial settlement indicator at instruction level can be updated at any time. The last value provided by the client remains effective until the instruction has been effectively settled or has been cancelled.

For internal and Bridge instructions, Clearstream allows clients to change the partial settlement indicator even for instructions that have already been partially settled. This change only affects the remaining quantity still to be settled.

The values below are accepted in CFS Portal and Swift:

- PART: Eligible for partial settlement;
- NPAR: Not eligible for partial settlement.

Partial settlement threshold

Clearstream's partial settlement algorithm (used for internal and Bridge transactions) considers both the minimum and multiple tradable amounts of the underlying security before any partial settlement attempt.

The settlement algorithm ensures that the remaining security quantity to be settled, after a partial settlement, is at least equal to the minimum settlement amount and in line with the multiple settlement amount.

Cancellation of a partially settled instruction

Clients have the possibility to cancel their partially settled instruction with either the original or the remaining quantity/cash amount as CFCL does not validate the quantity/cash amount of the cancellation/modification. Except for release modification where the quantity will be taken into account.

6.12 CSDR Settlement Discipline Regime

Introduction

Important note

While CFCL does not fall under the CSDR (Central Securities Depositories Regulation) but rather MiFID (Markets in Financial Instruments Directive), it's important to consider that CBL (Clearstream Banking Luxembourg) will be acting as a sub-custodian for CFCL's Investment Fund business. When Investment Funds are settled in local CSDs (Central Securities Depositories) or via the Bridge against Euroclear participants, this relationship should be considered by CFCL clients.

CFCL clients are responsible for ensuring the timely settlement of their settlement transactions. Any penalties accrued due to delays will be passed from CFCL to their clients. For penalties accrued from the counterparty of the CFCL client, penalties will be collected and credited to CFCL account. CFCL will support transparency for its clients through reporting and CFS Portal functionality

In relation to Regulation (EU) No 909/2014 of the European Parliament and of the Council of 23 July 2014 on improving securities settlement in the European Union and on central securities depositories (CSDR) and the specific requirements prescribing a "Settlement Discipline Regime" (SDR), CBL herewith describes its services relevant for CFCL clients.

The information mainly covers:

- The calculation, application and reporting of daily settlement fails cash penalties and their subsequent monthly payment through CBL, including penalties calculated and reported by the T2S penalty mechanism and European domestic markets to CBL;
- The relevant clients' reporting obligations towards CBL in the event of the execution of CSDR mandatory buy-ins, if and when applicable;
- Aspects of the settlement fails monitoring and measures agreed with relevant CFCL clients to improve their settlement efficiency.

Important note: CFCL clients are required to use CFS Portal to subscribe to receive Swift MT537 penalty messages or query penalties information online. Access to the CFS Portal is required to address penalties "appeals" to CFCL (exceptionally, CFCL may accept appeal requests raised via MT599). Further information can be found in the "CFS Portal User Guide".

Disclaimer: As described in detail in this chapter, various reference data used for the penalties calculation is based on data published and maintained in ESMA databases for which CBL is not responsible for. Hence, CBL cannot provide any representation or warranty that the relevant data used by CBL is complete, accurate or up to date. As a result, CFCL and then CBL will not accept any client appeals nor claims for damages in this regard.

Settlement fails cash penalties

The following chapters provide detailed information about the daily and monthly processing of SDR cash penalties.

Penalties lifecycle and business days calendar

This chapter covers the penalties lifecycle for CBL internal, Bridge and domestic settlement.

The following scenarios apply:

- Daily events:
 - Calculation and application of cash penalties; -Daily reporting.
- Monthly events:
 - Appeal period;
 - Monthly reporting of "global net amounts" (GNA) to be paid or received; - Actual collection and distribution of "global net amounts".

The illustration below summarises the lifecycle of the cash penalties.

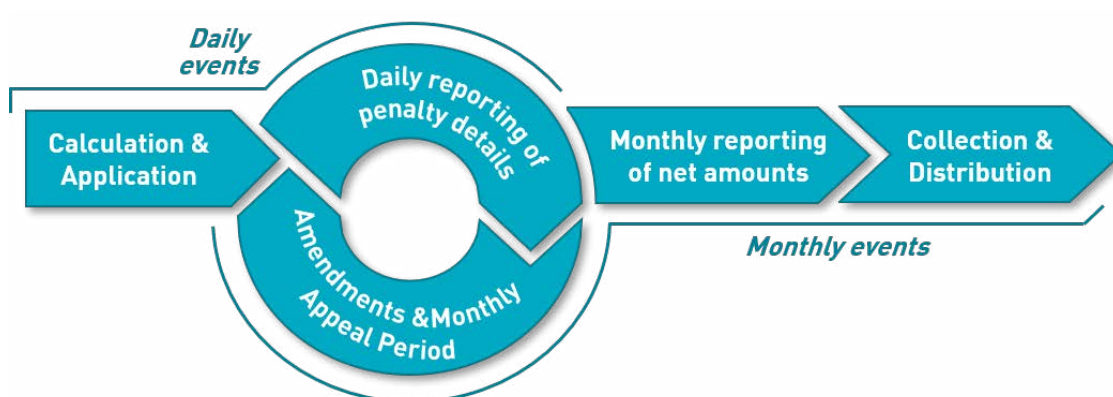

Figure 6.3 Daily and monthly events

Daily and monthly events apply for the business days defined below.

Individual business days (BDs) calendars

BDs are only relevant for the application of daily events defined below.

Based on the above, a penalty does not apply:

- For "free of payment" instructions: For the days when Creation is closed.
- For "against payment" instructions: For the days when Creation and/or the payment system of the relevant currency is closed (if the cash leg is to be settled in the payment system of the relevant currency).

Note: CFCL internal, CBL and Euroclear Bridge settlement against payment in CBL is allowed even if the central bank of the settlement currency is closed. Hence, cash penalties apply if settlement fails in Creation on such day.

BDs in Creation are all days except:

- Saturdays and Sundays;
- 25 December; and
- 1 January.

Common Penalties Business Days (PBDs) calendar

In the ECSDA "Penalties Framework", ECSDA Member CSDs agreed on common principles for a harmonised process in the definition and counting of "business days" for the CSDR penalties management. Such specific "business days" are called "Penalties Business Days" (PBDs).

PBDs are only relevant for the application of monthly events defined below.

Penalties lifecycle

- Daily events:
 - Calculation and application:
 - Cash penalties are calculated and applied on each business day, depending on the Calculating-CSD.
 - Daily reporting.
 - Cash penalties, including details on the calculation and related transaction, are reported on each business day. The daily report sent on a given business day includes cash penalties calculated and applied for the previous business day.
- Monthly events:
 - Monthly appeal period:

The appeal period for cash penalties starts on the day the cash penalty is calculated and applied. Such appeal period ends latest on the 10th PBD of the next calendar month .

Note: If CBL or the domestic market is closed on this day, the appeal period already ends on the previous PBD.
 - Monthly reporting of global net amounts (GNA):

CBL sends monthly reports for month M usually on the 14th PBD on month M+1 but as soon as the information is provided to CBL and successfully reconciled by CBL. See section "[Monthly reports](#)" for details.
 - Collection and distribution:

Upon calculation of the GNA, CBL generates "against payment instruction with zero quantity of securities" settlement instructions usually on the 15th PBD of M+1 to settle (that is, collect/distribute) the GNA on the 18th PBD of M+1.

See section "[Monthly collection/distribution of cash penalties](#)".

Cash penalties mechanism

As per Article 7(2) of CSDR, Clearstream Banking established a penalty mechanism for each securities settlement system it operates.

CBL applies its own penalty mechanism for internal settlement fails occurring in its securities settlement system Creation, including for failing Bridge delivery instructions.

For external settlement fails outside Creation, including domestic as well as failing Bridge receipt instructions, CBL processes cash penalties as reported to CBL from the penalties calculating (I)CSD or CBL's agent/depository. In such cross-CSD settlement fails scenario, involving multiple CSDs, only the CSD where settlement actually takes place is responsible for calculating and applying the cash penalties. This CSD is referred to as the "Calculating CSD". The CSD, acting as an Investor-CSD, applies the daily amounts reported by the Calculating CSD and reports them afterwards to its own clients.

The table below summarises, per type of settlement, the relevant penalty mechanism that is calculating, applying and reporting the cash penalties.

Settlement type	
<p>Internal (CBL-CBL)</p> <p>Settlement instructions with a counterparty in CBL</p>	All cash penalties are calculated and applied by the CBL penalty mechanism.
<p>Bridge (CBL-EB)</p> <p>Settlement instructions with a counterparty in Euroclear Bank (EB)</p>	<p>Cash penalties on CBL deliveries are calculated and applied by the CBL penalty mechanism.</p> <p>Cash penalties on CBL receipts are calculated by the EB Penalty Mechanism.</p>
<p>External settlement (CBL- domestic market)</p> <p>Settlement instructions with a counterparty neither in CBL nor in EB</p>	<p>For settlement with counterparties in a T2S-In CSD, all cash penalties are calculated and applied as reported by the T2S penalty mechanism.</p> <p>For settlement with counterparties in a non-T2S CSD, cash penalties are calculated and applied as reported by the local CSD's penalty mechanism.</p>

Figure 6.4 Penalty mechanisms

Cash penalties scope and currency

The descriptions in the following chapters apply to the CBL penalty mechanism. For detailed information relating to external settlement in domestic markets, please refer to the Market Link Guides.

In relation to the applicable penalties amounts currencies, for CFCL internal, CBL and Bridge transactions, cash penalties are calculated and applied in Euro (EUR), only.

Hence, the CBL penalty mechanism applies an exchange rate to calculate a cash penalty if:

- The reference price or denomination currency of the financial instrument is not expressed in EUR.
- The amount of cash to be delivered is not expressed in EUR (for settlement fails due to "lack of cash").

For fails due to lack of cash, the (foreign) currency of the cash leg is used to identify the relevant currency discount rate to calculate the penalties (see section "[Cash discount penalty rates](#)").

Important note: Cash penalties not calculated by the CBL penalty mechanism or for Bridge transactions will be reported to and have to be paid by the CFCL clients in the currency as applied by the relevant penalty mechanism. Neither CBL or CFCL will not process any currency conversion.

Instructions subject to cash penalties

The CBL penalty mechanism calculates and applies cash penalties for all OTC as well as stock exchange transactions settlement instructions on Creation that are:

- Matched; and
- Failing to settle (in part or in full) on and after their Intended Settlement Date (ISD).

This applies for all CFCL instructions types:

- Delivery or receipt versus payment;
- Delivery or receipt free of payment;
- Against payment instruction with zero quantity of securities.

The CBL penalty mechanism does not apply cash penalties:

- If the client is restricted from settlement, regardless of the reason;
- If the security is restricted from settlement, regardless of the reason;

Market Claims and Transformations (corporate actions on flows) are subject to cash penalties. However, corporate actions on stock are not subject to cash penalties.

If there are cancellations:

- If a settlement instruction is cancelled prior matching, no cash penalty will be applied.
- If a settlement instruction is matched, cash penalties will be applied until the instruction is bilaterally cancelled.

Note: Penalties applied for transactions bilaterally cancelled after the ISD will not be removed.

Specificities for some CBL services

Investment Funds Services

All settlement instructions generated for CFF Qualified Investment Fund Shares from/to a Fund Issuance Account (FIA) are out of scope as Fund Issuance Accounts are not considered as client under the definition of CSDR.

New issues settlement

Transactions that fail to settle on ISD (and when the ISD is the same as the issuance Closing Date) will be subject to cash penalties.

This applies to:

- Syndicated new issues distributions (delivery from the Lead manager to allotees);
- Non-syndicated new issues distributions (delivery from the Issuing and paying agent to the Dealers).

Penalties apply also when the distribution is eligible for back valuation and the instructions settle on the business day following issue or closing date with back valuation to issue or closing date. Penalties will be applied based on the reason for failing at the end of the applicable settlement window, either the mandatory settlement window or the optional settlement window.

No settlement fail penalties apply when ISD of the client instruction is before the closing date of the security and the instruction is withheld by CFCL from CBL or Bridge settlement due to a securities new issue being in status "undistributed".

Back-to-back transactions

CBL offers access to and settlement as well in non-European markets. If settlement actually takes place in a CSD outside the EU/EEA (that is, not subject to CSDR), no CSDR cash penalties apply.

In the context of a back-to-back transaction, when one transaction is to be settled in CBL, and the other transaction in a CSD outside CSDR reach, the party buying and selling the securities might be imposed to pay cash penalties, while not being the party at fault.

This scenario is illustrated below.

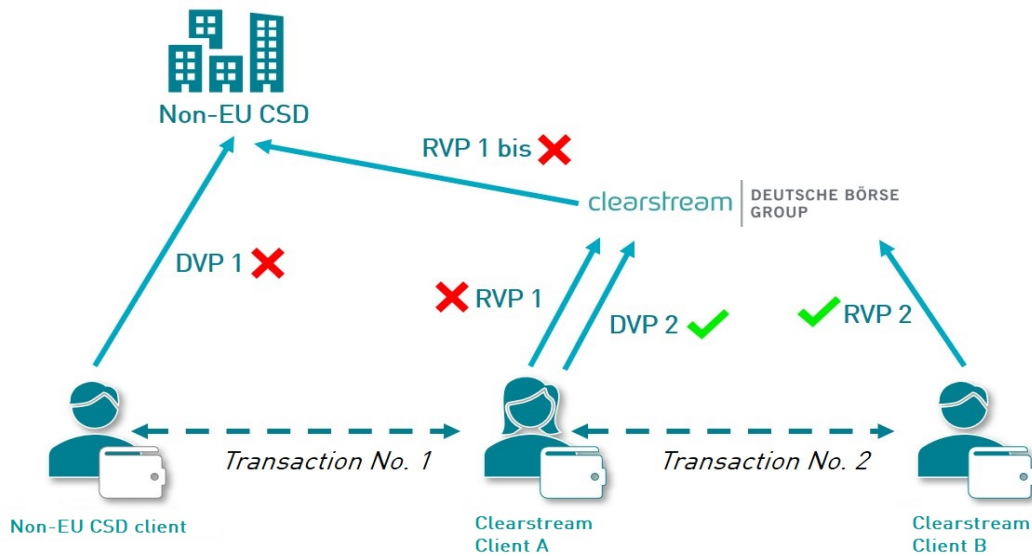

Figure 6.5 Back-to-back transaction.

If the counterparty in a CSD not subject to CSDR fails to deliver the securities, the CBL (CFCL) client A does not receive the securities, then CBL (CFCL) client A:

- Will not receive a cash penalty credit.
- Will be imposed to pay cash penalties to CBL (CFCL) due to the settlement fail versus CBL (CFCL) client B.

CBL (CFCL) does not accept penalties appeals due to such "imbalances".

Financial instruments subject to cash penalties

A financial instrument is considered by CBL as being eligible for cash penalties if:

- The ISIN is listed in the Financial Instrument Reference Data System (FIRDS) database, published by ESMA and;
- The ISIN is not in the list of exempted shares as per the EU Short Selling Regulation (SSR).

Note: The FIRDS database includes non-EU securities traded or admitted to trading on an EU trading venue. Unless exempted, these non-EU securities are eligible for cash penalties when the actual settlement takes place in an EU/EEA CSD.

In line with ESMA Q&As, changes in the ISIN scope as reflected in the ESMA databases apply for penalties that are calculated on ESMA database update publication date + 1 business day.

The FIRDS database may include financial instruments that were already terminated. CBL does not apply cash penalties for settlement fails on financial instruments that are terminated, for the days after the termination date.

Types of cash penalties

The CBL penalty mechanism distinguishes two types of cash penalties:

- Late Matching Fail Penalties (LMFP);
- Settlement Fail Penalties (SEFP).

Late Matching Fail Penalties (LMFP)

The CBL penalty mechanism calculates and applies LMFP to settlement fails on instructions eligible for cash penalties if such settlement instruction matches after the relevant settlement cut-off time of its ISD.

Figure 6.6 below illustrates whether LMFP applies or not. If matching occurs during:

- The period in green, then no LMFP applies;
- The period in red, then the CBL penalty mechanism calculates and applies LMFP (provided that the settlement instruction is eligible for cash penalties).



Figure 6.6 Eligibility to LMFP

For a given settlement instruction, the CBL penalty mechanism calculates and applies LMFP only once, that is, on the day the settlement instruction matches. Such LMFP applies retroactively to all business days, from the ISD to the matching date. For each past fail date a daily reference price applicable for the single fail date is used for the penalties calculation, that is, different reference prices may apply if the matching occurs more than one business day after the ISD.

The CBL penalty mechanism considers each business day where the settlement instruction was due to settle, from the ISD and until the actual matching date:

- Including such matching date if the instruction matched after the end of the relevant settlement cut-off;
- Excluding such matching date if the instruction matched before the end of the relevant settlement cut-off.

Figure 6.7 below illustrates the application of LMFP:

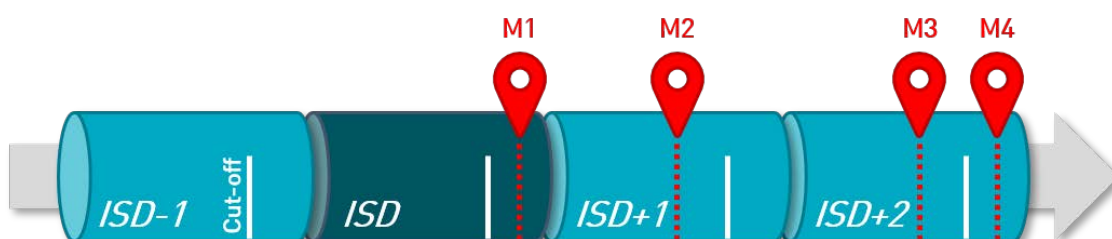

Figure 6.7 Application of LMFP

- If matching occurs on ISD after the cut-off time (M1), then the CBL penalty mechanism calculates one LMFP on ISD+1, applying to one single day, the ISD.
- If matching occurs on ISD+1 before the cut-off time on such ISD+1 (M2), then the CBL penalty mechanism calculates one LMFP on ISD+1, applying to one single day, the ISD.
- If matching occurs on ISD+2 before the cut-off time on such ISD+2, then the CBL penalty mechanism calculates one LMFP on ISD+2, applying to all business days from ISD until matching, excluding such matching day, that is, the ISD and ISD+1.

- If matching occurs on ISD+2 after the cut-off time on such ISD+2, then the CBL penalty mechanism calculates one LMFP on ISD+3, applying to all business days from ISD until matching, including such matching day, the ISD, ISD+1 and ISD+2.

The LMFP is charged to the CFCL client that was last to provide its settlement instruction (or modification to its settlement instruction, if applicable) for the period between the ISD and the day of instruction matching. The acknowledgement timestamp of the instruction is used to determine the failing client.

If both clients send their instructions late, after the end of the relevant settlement period of the ISD, only one of the two clients of a transaction is charged with the LMFP, that is, the client who was last to enter its "settlement instruction". If settlement instructions are entered by CBL on behalf of its client(s), as it is the case for market claims, the same rule applies. In the rare event when the timestamps are identical, the securities delivering client will be charged by default.

LMFP applies even if the settlement instructions have been bilaterally cancelled after matching but before the end of the relevant settlement cut-off (in this situation, however, SEFP will not apply, see section "[Settlement Fail Penalties \(SEFP\)](#)").

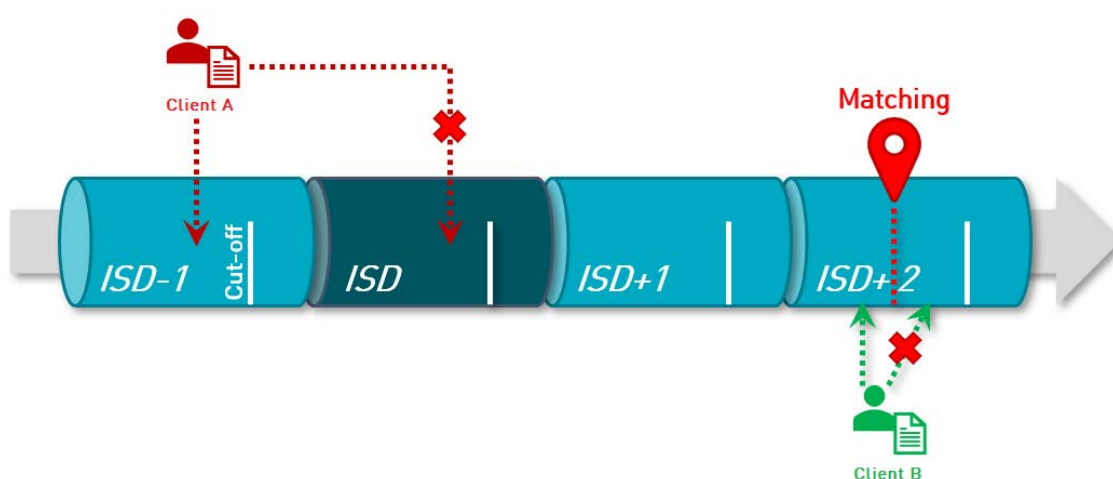

Figure 6.8 Application of LMFP on cancelled settlement instructions

The CBL penalty mechanism will identify two situations where LMFP is not applied:

- Re-denomination
 - If a re-denomination event occurs (for example, a change in the denomination currency of a security), CBL will:
 - Cancel the relevant pending settlement instructions;
 - Amend the relevant static data in its system; and
 - Re-instruct the settlement instructions, cancelled during the first step, taking into consideration the amendments processed in the second step.

Because the settlement instructions are re-instructed, keeping the original intended settlement date, and matched, the re-instructed settlement instructions are subject to LMFP if matching occurs after the ISD.

The CBL penalty mechanism includes a specific exemption for this process and does not apply LMFP on re-instructed settlement instructions in the context of the re-denomination process. CBL (CFCL) clients are not required to provide any specific information or to perform any specific task to benefit from this exemption.

- New settlement instruction resulting from a partially successful buy-in:

As required by CSDR, in case only parts of the failing securities delivery quantity were bought in, CBL clients shall:

- Bilaterally cancel their initial failing settlement instruction; and
- Re-instruct for the remaining quantity of securities not bought-in.

Consequently, cash penalties will only be calculated and applied for the remaining quantity of securities instead of the initial full quantity. When the new settlement instruction is reentered by the client with the original (past) ISD, this settlement instruction will become subject to LMFP.

Only under the condition that both settlement instructions contain the required "buy-in partially successful" indicator the CBL penalty mechanism will not apply LMFP in such cases (please refer to the "Swift User Guide" for details).

Settlement Fail Penalties (SEFP)

The CBL penalty mechanism calculates and applies SEFP to settlement fails if the settlement instruction:

- Is matched before the end of the relevant settlement period of the current business day;
- Has reached its ISD;
- Fails to settle (in part or in full) and remains to settle until the end of the relevant settlement cutoff of that business day (if not bilaterally cancelled).

For a given settlement instruction, multiple SEFPs may be calculated and applied, that is, one SEFP per business day when the settlement instruction fails to settle. The CBL penalty mechanism calculates and applies one SEFP at the end of each business day, considering the settlement status and reason at the end of the relevant settlement cut-off, provided that all three criteria mentioned above are fulfilled.

Figure 6.9 below illustrates the application of SEFP.

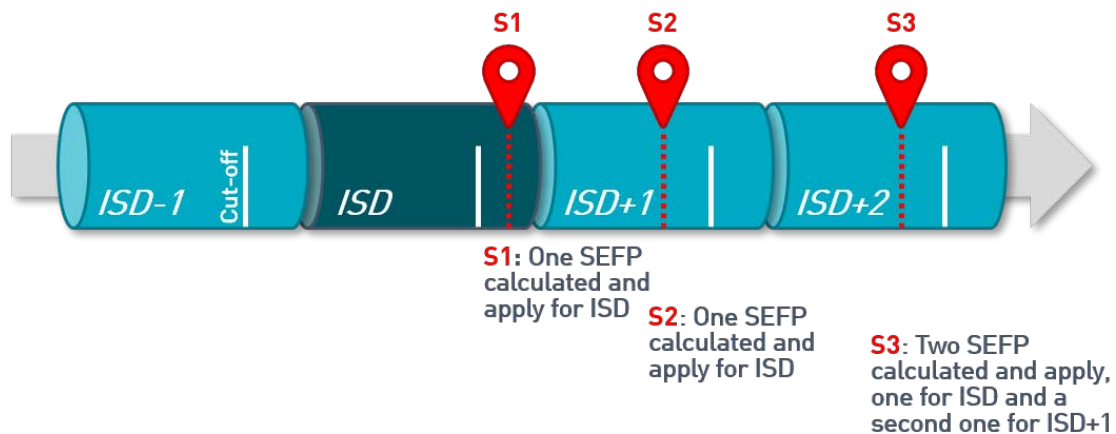

Figure 6.9 Application of SEFP

- If settlement instructions fail to settle before the end of the relevant settlement cut-off on ISD, but settle overnight (S1), then the CBL penalty mechanism calculates and applies a SEFP on ISD.
- If settlement instructions fail to settle on ISD but settle on the next business day before the end of the relevant settlement cut-off, then the CBL penalty mechanism calculates and applies a SEFP on ISD, but not on ISD+1.

- If settlement instructions fail to settle on ISD and ISD+1 but settle on ISD+2 before the end of the relevant settlement cut-off, then the CBL penalty mechanism calculates and applies:
 - One SEFP on ISD for settlement fail on ISD; and
 - One SEFP on ISD+1 for settlement fail on SD+1 but not on ISD+2. The SEFP will be charged to the client.
- Having set the settlement instruction "On Hold";
- Being lack of securities, provided that no settlement instruction is "On Hold";
- Being lack of cash, provided that no settlement instruction is "On Hold" or lacks securities.

Note: If both settlement instructions are "On Hold", then both parties to the transaction will be charged with a SEFP to be paid to the counterparty. The different calculation methods described in section "[Types of cash penalties](#)" settlement fails on deliveries and receipts against payment apply. CBL does not calculate penalties when a settlement transaction failed due to CBL's own action for example in relation to settlement instruction refusal or de-selection from a Bridge settlement processing cycle in special occasions.

The table below summarises the party to the transaction that is to be charged with the SEFP, depending on the settlement fail reason:

Buyer/Seller	Has the settlement instruction "On Hold"	Does not have enough cash available	Instruction released and sufficient cash available
Has the settlement instruction "On Hold"	The Buyer is imposed to pay a SEFP to the Seller. The Seller is imposed to pay a SEFP to the Buyer.	The Seller is imposed to pay a SEFP to the Buyer.	The Seller is imposed to pay a SEFP to the Buyer.
Does not have sufficient securities to settle	The Buyer is imposed to pay a SEFP to the Seller.	The Seller is imposed to pay a SEFP to the Buyer.	The Seller is imposed to pay a SEFP to the Buyer.
Instruction released and sufficient securities	The Buyer is imposed to pay a SEFP to the Seller.	The Buyer is imposed to pay a SEFP to the Seller.	No cash penalty applies.

Figure 6.10 Identification of the client to be penalised

Note: The CBL penalty mechanism will not apply any SEFP if the settlement instruction becomes invalid: A settlement instruction may become invalid/fall into a repair mode if it no more meets the validation rules (it will not be rejected). In this situation, the settlement instruction will not be eligible for settlement and the relevant client will be required to cancel and re-instruct their settlement instruction. If the invalid instruction is not cancelled, then it will result in a settlement fail. However, the CBL penalty mechanism does not apply to any SEFP if the settlement fail is due to the settlement instruction being invalid. CBL (CFCL) clients do not need to provide any specific information or to perform any specific task to benefit from this exemption.

Calculation and application of cash penalties

The CBL penalty mechanism applies a calculation method that is depending on the type of settlement instruction of the client causing the settlement fail. The table below describes the different penalties calculation methods:

Calculation Method	SECU	MIXE	CASH
Formula	Security Penalty Rate X Quantity of undelivered securities X Price of the security for the relevant business day	Cash Discount Penalty Rate X Quantity of undelivered securities X Price of the security for the relevant business day	Security Penalty Rate X Amount of cash failed to be delivered
Type of settlement instruction of the failing client	<ul style="list-style-type: none"> • DVP • DFP • RFP 	<ul style="list-style-type: none"> • RVP 	Against payment instruction with zero quantity of securities

Figure 6.11 Determination of the calculation method

Note: For partial settlement, the cash penalty amounts are calculated based on the remaining quantity of securities to be settled.

Security penalty rates

The Security Penalty Rate is the fixed rate applied for settlement fails due to "lack of securities", depending on:

- The CFI-classification of the relevant financial instrument;
- The liquidity indicator of the relevant financial instrument;
- Whether the underlying securities trade occurred on a SME Growth Market, or not.

The security penalty rates as published by ESMA apply.

If there are rate changes, for penalties calculated by CBL and independent from the ISD of the failing settlement transaction, the latest penalty rates as published by ESMA apply for all new or modified penalties as of the entry into force date of the change defined by ESMA.

The below table defines the applicable Security Discount Penalty Rates depending on the abovementioned criteria:

Type of settlement fail	Classification of the security (CFI Code)	CSDR Classification	Liquidity Indicator	Traded on a SME Growth Market	Penalty Rate (in bps)
Lack of securities	E*****	SHRS	True	No	1.00
			False	No	0.50
			n.a.	Yes	0.25
<i>(The applicable Penalty Rate is referred to as "Security Penalty Rate")</i>	DN**** D**T** D**C**	SOVR	n.a.	n.a.	0.10
			D****, Except DN****, DY****, D**T** and D**C**	No	0.20
				Yes	0.15
	R*****	SECU	n.a.	No	0.50
			n.a.	Yes	0.25
	CE****	ETFS	n.a.	No	0.50
			n.a.	Yes	0.25
	C**** Except CE****	UCIT	n.a.	No	0.50
			n.a.	Yes	0.25
	DY**** Except DY*T** and DY*C**	MMKT	n.a.	No	0.20
n.a.			Yes	0.15	
TTN***	EMAL	n.a.	No	0.50	
		n.a.	Yes	0.25	
Other	OTHR	n.a.	No	0.50	
		n.a.	Yes	0.25	

Cash discount penalty rates

The Cash Discount Penalty Rate is the rate applied by the CBL penalty mechanism for settlement fails due to a "lack of cash", depending on the underlying settlement or payment currency.

The applicable Penalty Rate is referred to as "Cash Discount Penalty Rate", that is, the official interest rate for overnight credit charged by the central bank issuing the settlement currency with a floor of zero.

The applicable cash penalty rates (that is, the daily interest rates) are derived per settlement currency as described in the "ECSDA Penalties Framework".

Note: The ECSDA Penalties Framework is describing for each currency how to derive the Central Bank rate for penalties calculation purposes applies (for example, for EUR, the "marginal lending

facility rate" defined by the European Central Bank (ECB) and published on its website, divided by 360, is used).

The cash discount rates as published per currency by the relevant Central Bank apply. If there are rate changes, these will be considered by CBL as of the following business day for all new penalties in the case of EU/EEA currencies as well as CHF, GBP, JPY and USD. Otherwise, rate changes will apply as of the second business day of the month following the change.

Liquidity indicator

The liquidity indicator is a binary classification of securities applying only when the financial instrument type of the security derived from its CFI code is "SHRS".

The information on whether the share is considered a liquid or an illiquid share is derived from the ESMA FITRS database.

If settlement fail applies to a share and the liquidity indicator for the share is not available or the instrument type category is unknown, then it will be considered as "illiquid".

In line with ESMA Q&As, changes in the liquidity indicator as reflected in the ESMA FITRS database apply for penalties that are calculated on ESMA database update publication date + 1 business day.

SME Growth Market transactions

The CBL penalty mechanism applies a lower security penalty rate, if the transaction in the financial instrument identified in the settlement fail was actually traded on a SME Growth Market.

Such security penalty rate is applied by the CBL penalty mechanism, only if:

- oBoth instructions show the same "place of trading" four-digit Market Identifier Code (MIC); and
- oThe trading venue identified in the field is included in the latest available list of SME Growth Market Trading Venues maintained and published by ESMA (that is, to be considered by CBL; the SME MIC must be listed in the ESMA database on the day the penalty is calculated).

Daily reference price

The CBL penalty mechanism applies the reference price of the security for the business day when the settlement instruction actually failed to settle:

- For shares and similar instruments, the reference price is the closing price of the "most relevant market in terms of liquidity".
- For other securities, the reference price is the closing price of the trading venue with the highest turnover.

If the cash penalty is a LMFP applying on multiple days, then the CBL penalty mechanism calculates the LMFP, applying the relevant reference price for each applicable day. If the LMFP applies on business days more than three months in the past, then, for those days, the CBL penalty mechanism applies the oldest available reference price, the three-months old price.

The reference price used will be the last available price of the "MiFID trading venue" relevant for an ISIN, or, if not available, another trading venue, or derived by CBL from its own sources or a default (for example, issuance) price.

Update of a cash penalty

A change of the reference data used for the calculation of a cash penalty may be considered by the CBL penalty mechanism maximum until, and including, the 12th PBD of the next month. When reference data needed to calculate a penalty becomes available only after the appeal deadline ended, such new penalty (NEWP) will still be considered by CBL in its daily and monthly penalties reports.

Unless a cash penalty can no longer be modified (for instance, is inactive or has been removed), the CBL penalty mechanism automatically re-calculates existing and active cash penalties impacted by a

change in the reference price of a security for the relevant business day the cash penalty applies. Once re-calculated, the updated cash penalty is reported to the relevant clients via the daily reports described in section "[Daily reports](#)".

Daily and monthly reporting of cash penalties

CBL reports cash penalties, including details on the calculation and the related settlement instruction, on a daily basis.

In addition, CBL provides monthly reports usually on the 13th PBD (only for Bridge) and after (usually on 14th PBD, for CBL internal, domestic markets and upon receipt), each month, considering active cash penalties calculated and applied on the previous month. These monthly reports include one monthly "Global Net Amount" (GNA) each, per counterparty-CSD and per currency, as well as the details of the relevant daily cash penalties composing the GNA.

CBL reports details on cash penalties exclusively via ISO 15022 MT537.

Upon receipt of the CBL reporting, if the client identifies during its reconciliation process, for example, inconsistencies, missing reporting or penalties and mismatches, this should be reported as soon as possible and before the end of the appeal period to CBL via the standard communication channels or the CFS Portal "appeals" function. The CBL penalties reporting shall be considered as complete, correct and final after the end of the appeal period as no corrections can be done after that point in time.

Important note: The reports must be actively subscribed for and scheduled by the CFCL clients via CFS Portal. The same applies for querying penalties information via CFS Portal.

For details about the penalties reporting content, please refer to the connectivity manuals and user guides on the Clearstream Banking website.

For cases where the daily penalties reporting from its supplier(s) is delayed, CFCL will include these penalties upon receipt and in the next available daily report batch. The monthly reports are provided to clients upon receipt and after successful reconciliation by CFCL versus the daily reports' data.

Daily reports

CFCL reports newly calculated cash penalties and amendments to already calculated cash penalties in two separate reports (covering new and modified penalties).

CFCL clients can select the time(s) when to receive their daily reports (even though new and amended cash penalties are reported in two separate messages, the reporting times scheduled apply to both (for instance, new and modified penalties) reports, that is, it is not possible to receive only one of the two reports. More specifically:

- oThe report including new cash penalties only contains new cash penalties calculated or received since the last report.

- oThe report including amended cash penalties only contains amendments to cash penalties processed by CFCL or received from its depositories since the last report.

If for a given time scheduled by the CFCL client, there is no new or amended cash penalty to be reported, then the client will receive a "no activity" daily report (separate for "new" and "amended" penalties).

Monthly reports

CFCL may provide several monthly reports for a given period because of its multiple domestic markets links available. Nevertheless, the monthly report for a given market link will only be reported once.

The table below summarises the expected time per market link.

Clearstream Fund Centre (CFCL)

Internal (CFCL-CFCL or CFCL-CBL) Settlement instructions with a counterparty in CBL.	On the 14th PBD of the month, between 08:30 and 09:00 CET (after daily calculation of new cash penalties and re-calculation of amended cash penalties).
Bridge (CBL-EB) Settlement instructions with a counterparty in Euroclear Bank (EB).	On the 13th PBD of the month, between 09:00 and 10:00 CET (after successful reconciliation of the cash penalties with EB).
External settlement (CBL- domestic market) Settlement instruction with a counterparty neither in CBL nor in EB.	For settlement with counterparties in a T2S-In CSD, on the 14th PBD of the month, between 08:30 and 09:30 CET (after successful of the cash penalties calculated by the T2S penalty mechanism). For settlement with counterparties in a non-T2S CSD, after receipt and successful reconciliation of the cash penalties calculated by the local penalty mechanism.

Figure 6.12 Expected times for generation of the monthly reports

If, for a given month, there is no active cash penalty to be reported, CFCL will not generate any "no activity" monthly reports, separately for "new" and "updated" penalties and for each reporting batch that the client has subscribed to.

The CFCL monthly penalty MT537 PENA report does not include any "removed" penalties while the monthly aggregates in the CFS Portal currently include them. On the other hand, the MT537 PENA includes penalties with "computed" flag ("CMPU") "yes" and "no", while CFS Portal only includes penalties with "CMPU" flag "yes".

Monthly collection/distribution of cash penalties

"Monthly penalties collection/distribution" refers to the actual debit or credit of the monthly "Global Net Amount(s)" (GNA) reported by CFCL to its clients (per counterparty-CSD and per penalties currency).

CBL will collect or distribute each GNA on the 18th PBD of the following calendar month via "against payment instruction with zero quantity of securities" settlement instructions towards its clients. The settlement instructions will be generated by CBL in Creation on behalf of its clients using the relevant five-digit Creation securities and (default) cash account of each client to collect the amounts due from or distribute the amounts entitled to be received by the CBL (CFCL) clients.

Note: Cash penalties applied to a CFCL client's "Single Securities Accounts" will be collected/distributed on the related CFCL client's "Single Cash Account" as per standard settlement process.

The penalty amounts to be processed by the CFCL clients can be derived from the monthly penalty reports and "against payment instruction with zero quantity of securities". Penalties settlement instructions. Penalties are not reported through the standard monthly client invoice.

Global Net Amount (GNA)

The GNA is the net amount of cash penalties to be paid (if negative) or received (if positive).

For each client, CFCL will net the amount of cash penalties:

- Per currency
- Per Counterparty's CSD/ Account Servicer / Depository

The GNA is further netted per CBL's depository (indeed, CBL clients may settle with a single counterparty via two different market links, depending on the financial instrument, CBL does not net cash penalties from different market links).

Each GNA reported by CBL (CFCL) to clients will trigger two "against payment instruction with zero quantity of securities" settlement instructions:

- If the GNA is negative, the amount is due to be paid by the client, then CBL will generate:
 - One instruction to debit the client's account;
 - One instruction to credit the relevant dedicated account of CBL.
- If the GNA is positive, the entitled amount is to be received by the client, then CBL generates:
 - One instruction to debit the relevant dedicated account of CBL; -One instruction to credit the client's account.

CBL automatically matches both "against payment instruction with zero quantity of securities" settlement instructions.

For the penalties to be paid or collected at domestic markets level, these can be charged, collected and distributed to the clients once CBL has successfully reconciled the domestic markets reports or actually received cash from the local market. Therefore, the payments can be delayed due to discrepancies in the cash penalties processes, notably with respect to the pay dates, applied in the various markets.

Late or missing cash funding from CFCL client(s)

If CFCL clients do not provide the required cash amount(s) in the currency(ies) as reported by CFCL in its monthly penalty report (see sections "[Monthly collection/distribution of cash penalties](#)" and "[Monthly reports](#)"), CFCL may:

- Contact and urge the failing clients for immediate feedback and action as well as written information on the mitigating actions taken to avoid future penalties payments fails due to the lack of cash funding to meet their penalties payments obligations;
- In parallel, identify any alternative cash accounts maintained under the same client LEI and, if available, transfer the required cash amount, in line with the CFCL GTCs without prior client consent.

Important note: To avoid delays in the settlement of penalties payment processing CFCL clients are required to comply with their obligations to timely and sufficiently fund their Creation cash account to ensure the settlement instruction related to penalties can settle in the night-time settlement cycle for value date 18th PBD. Reference is made to the Article 29 of the General Terms and Conditions and in particular to the paragraphs 3 and 5. Clients are reminded that as failing clients, they have the obligation to pay the Penalties in accordance with the CSDR and to fund their relevant accounts to enable CBL to charge, collect and distribute the Penalties to the counterparties. In the event of noncompliance with such payment obligations by clients, CBL reserves the right to force the debit of such payment in any relevant account(s) of the clients and/or initiate a foreign exchange (FX) transaction to convert and debit the corresponding cash amount held by the client in another currency into the currency required for the payment of the amount due and/or to inform the relevant supervisory authorities in charge of the enforcement of penalties mechanism in accordance with Article 8 CSDR as well as to inform the impacted counterparty(ies).

For the payment of the monthly GNA, CBL is redistributing the amounts actually collected on or after the intended pay date of the GNA. This means, if there is late or insufficient cash funding of the cash account of to be debited CFCL client(s), CBL (CFCL) does not delay the cash distribution until all penalties to be collected have actually been paid by all to be debited CFCL clients. However, CBL (CFCL) neither collects nor distributes partial GNAs: If the cash balance of a client's cash account is insufficient to collect the full amount due, the debiting penalty PFOD instruction will remain pending until the full penalty cash amount has been funded. Similarly, credit penalty PFoDs will only be settled

in full or remain pending until CBL has collected the required cash amount. As a final step, if not all debit penalties could be collected by CFCL, corrective PFoD instructions may be entered in the month following the intended pay date of the GNA to recalculate the GNAs by excluding all penalties of the failing CBL client from the GNA calculation. Such recalculation may lead to debits of the counterparty(ies) of the failing CBL client(s) that were credited although the cash could not be collected from the failing CBL client (that is, their counterparty). The initial failing CBL internal PFoDs will be cancelled and the impacted clients may bilaterally claim their counterparty for the penalties due. This process applies as well in the event of a client insolvency.

Details of penalties settlement instructions

Once CBL has provided clients with their "Global Net Amounts" to be paid or received, it will generate "against payment instruction with zero quantity of securities" the settlement instructions on behalf of its clients. CBL (CFCL) clients are not required to generate any settlement instruction relating to the collection and distribution process of cash penalties.

- The settlement instructions are generated with Trade Date 16th PBD and Intended Settlement Date 18th PBD.
- The Settlement Transaction Type is "PAIR" or "TRAD".
- CBL uses a single common "dummy" ISIN LU2128008567 for all settlement instructions relating to cash penalties.
- CBL generates the settlement instructions with the highest possible settlement priority.
- The settlement instructions generated by CBL are not eligible for partial settlement.

CFCL will report the matching and settlement status for the instructions as per the client's standard reporting (via MT548, if scheduled by the client, and/or via CFS Portal).

CCP-related aspects

As per SDR Article 19 where the CSD client is a central counterparty, this client shall collect the cash penalties from its clearing members that caused the settlement fails and distribute the cash penalties to its clearing members that are affected by the settlement fails and report to CBL that the penalties have been processed on a monthly basis.

CBL identifies Creation accounts owned by CCPs in its books subject to the exemption under SDR Article 19 if requested in written form via MT599 or letter by the client that is a CCP for its account(s) to be labelled as "CCP account" in CBL's "Account Master" system. As result, cash penalties for relevant transactions where a counterparty to the transaction is a CCP identified as described above will be excluded by CBL from its monthly collection and distribution process.

When CCPs maintain accounts for CCP members' clearing activities and proprietary activities, the exemption described in SDR Article 19 shall only apply to CCP accounts used for their members' clearing activities, that is, accounts used by CCPs for their proprietary activities as well as accounts of CCPs' settlement agents shall not be subject to Article 19 but the standard cash penalties payments processing through CBL.

When CBL uses an agent/depository to allow settlement in a domestic market through CBL's omnibus account with its agent/depository, the standard penalties payment process applies.

Accordingly, for each client account being identified to belong to a CCP (see conditions described above), CBL does:

- Calculate and apply cash penalties for settlement fails on CCP cleared transactions sent to CBL.
- Report the calculated cash penalties, including details of the calculation and the related transaction.
- Provide the monthly report, including the monthly aggregated amounts of active cash penalties calculated in the previous month.

CBL does not collect nor distribute any penalties for such CCP penalties when at least one of the parties to the trade is a CCP and when the penalty is not considered for aggregation.

The "Bilateral Net Amount" per counterparty for those CCP clients is calculated and reported as per standard process, ensuring CCPs have all the necessary details to collect and distribute cash penalties for settlement fails on instructions submitted by those CCPs.

CCPs shall confirm the actual payment execution towards their clearing members to CBL on a monthly basis via MT599 or email to SettlementCSDR@clearstream.com as follows.

"Subject: CCPXXXXXX confirmation to CSDYYYYYY of penalties collected and distributed

Following the obligations established in Article 19 of the Commission Delegated Regulation (EU) 2018/1229, and in particular the obligation established in Article 19 (d), we kindly confirm that all penalties submitted by CBL to CCPXXXXXX and corresponding to the month of XXXXXX have been duly collected and distributed to the relevant clearing members of CCPXXXXXX".

The messages received by CBL will be recorded and archived.

Appeals

CBL (CFCL) clients may submit Appeal requests to CBL within a dedicated appeal period that starts once a new penalty has been reported by CBL and ends latest on the 10th PBD of the payment month.

CBL (CFCL) clients can submit appeals for any cash penalties reported by CBL, regardless of the CalculatingCSD. Appeal requests on cash penalties not calculated by the CBL penalty mechanism will be forwarded for further processing (when such appeals are rejected by the calculating-CSD or penalty mechanism (like T2S), CBL will subsequently reject the CFCL client's request).

CFCL clients shall submit appeal requests to CFCL in priority via CFS Portal. CFCL may, exceptionally, accept appeal requests raised via MT599 to the attention of PSG Settlement Operations. Like the appeal requests submitted via CFS Portal, such MT599 requests shall be sent to CBL within the dedicated appeal period that starts once a new penalty has been reported by CBL and that ends latest on the 10th PBD of the payment month. The MT599 to be sent to CEDELULLXXX titled "ATTN: Settlement CSDR/ PSG - Penalties Appeal request" shall contain:

- Client Account Number;
- Penalty Reference;
- Penalty Calculation Date;
- Penalty Currency;
- Appeal Type (Amendment, Removal, Re-inclusion, Other);
- Appeal Reason.

For appeal acceptance, an updated penalty report will be provided automatically. Rejected appeals will be charged as usual, no further response to the requesting client will be provided.

Appeals need to include the applicable appeal reason or a proper description for CBL to be able to assess the validity of the appeal request. Appeals without sufficient (mandatory or optional) appeal reasoning information will be rejected without further processing. A financial instrument suspension from trading will not be considered by CBL as valid appeal reason

Note: It is neither possible for CFCL clients to raise nor for CFCL to process appeals after the end of the appeal period. Hence, appeals should be raised as soon as the daily penalty information was made available to the CFCL clients and ensure appeals are regularly raised towards CFCL latest until the 5th PBD to allow for processing prior the end of the appeal period.

Any appeals received and processed by CFCL will ultimately either be in status:

- "Accepted"

The investigation performed by CFCL operational staff concluded that the appeal request is valid, and the relevant cash penalty has been amended accordingly, based on the information provided by the CBL client; amended penalties will be reported and labelled as such by CBL as "modified penalties"; or

- "Rejected"

The investigation performed by CBL or the domestic market concluded that the appeal request is not valid, and the relevant cash penalty not amended; rejected appeals will not trigger a dedicated reporting.

Note that rejected appeals will be subject to charges as per the CBL Fee Schedule and/or external fees (if applicable, for penalties calculated by domestic markets).

"Accepted" Appeals will lead either to the penalty:

- "Removal"
 - If insolvency proceedings are opened against the failing client.
 - If the ISIN of the financial instrument is suspended from settlement due to a reconciliation issue.
 - If settlement fail is due to a technical impossibility at (I)CSD level (for example failure of the infrastructure components, cyber-attack, network issues).
 - Due to another reason (the client's appeal request is requiring a free-text description). o Re-inclusion
 - The client's appeal request is requiring a free-text description.
- Amendment
 - Calculation Details requested to be adjusted:
- The Reference Price (If Calculation Method is not CASH);
- The currency of the Reference Price (If Calculation method is not CASH);
- The CSDR Classification Type;
- The Liquidity Indicator;
- The SME Growth Market Indicator;
- The Security Penalty Rate Type;
- The (Security/Cash Discount) Penalty Rate;
- The expected Penalty Amount;
- The client's appeal request is requiring a free-text description.

Please refer to the CFS Portal User Manual for further details about the submission and processing of Appeal requests.

Note: If an appeal request cannot be finalised before the monthly report generation, the penalty amount as reported by CBL will be charged.

Buy-ins

If and when applicable, CSDR Article 7.3 obliges trading parties and CCPs to initiate buy-ins for failing settlements in any financial instrument in scope that cannot be settled within a certain time period. Trading parties shall arrange the buy-in themselves in line with prescribed SDR rules and reporting requirements. For CCP-cleared transactions, the CCP shall initiate the buy-in.

Despite the fact that CBL has no role in the buy-in initiation process, CSDR requires to provide buy-in execution details for settlement instructions failing at CBL that were subject to mandatory buy-in initiation according to CSDR.

Once the buy-in process has been actually executed, the execution details shall be provided to CBL by the CBL client via a specific "MT530 "buy-in" message.

Please refer to our "CFS Portal via Swift" User Guide for details.

Important note: Any buy-in execution notifications are only used for the compliance of CBL and its clients with the relevant CSDR regulatory reporting and record keeping requirements of CSDs. They do not trigger any buy-in initiation, execution, settlement or other "CSDR mandatory buy-in regime" related activities on the side of CBL.

Monitoring Settlement Fails (settlement efficiency)

CSDR requires CBL to measure its clients' individual settlement efficiency (on CBL client LEI-level) to identify:

- The "Top 10" CBL clients (by settlement transactions value and volume) that are failing to deliver securities/ provide cash on ISD, including "late matching" fails, and report them to CBL's regulator (CSSF);
- "Consistently and systematically failing participants" (that may ultimately be suspended from settlement by CBL) comparing their settlement efficiency versus the CBL settlement system's overall performance.

Note: As CBL lacks the view on the CBL clients' underlying clients settlement data, CBL clients are encouraged to analyse the settlement behaviour as well as fail reasons, patterns and late matching situations at the level of their underlying clients.

CBL is also obliged to publish anonymised transactions' fails and efficiency data to the public.

Note: Only settlement fails caused by the client itself and subject to CSDR penalties are considered, that is, settlements outside EU/EEA CSDs are excluded from the assessment.

Top 10 failing clients identification and working arrangements

CBL identifies the "Top 10 failing clients" by their settlement fails value and volume on a monthly basis in line with the ESMA fails reporting guidelines.

The following metrics are applied by CBL:

CBL client efficiency: The efficiency calculation by number and by value considers (per client LEI) all eligible instructions of the previous month with: $100 - (\text{sum of fails} * 100 / \text{sum of eligible instructions})$. Eligible instructions include all matched instructions during the calculation period (that is, matched instructions settled or cancelled on or after ISD; instructions settled after ISD include all failure reasons (lack of securities/ cash and beyond). Fails for the client's efficiency are restricted to matched instructions settled after ISD due to the single client lack of cash (when receiving client) or lack of securities (when delivering client). Instructions cancelled or on-hold after ISD are counted in fails and are included in the number and value of eligible instructions.

Clients whose fails represent at least 0.1% (that is, those clients that, according to the CSDR text, "have the most significant impact on the securities settlement system") of the total settlement instructions fails by volume or by value in CBL and limited to ISINs subject to SDR will be subject to "working arrangements". This means CBL will notify the clients via email requesting them within two weeks to analyse and provide the main reasons for their settlement fails and confirm which CBL services or other measures they intend to apply as concrete means to enhance their settlement efficiency. The client feedback will be passed on to CBL's regulator.

Note: When CBL itself (acting as Investor-CSD in another CSD on behalf of the CBL clients) is identified as a "Top 10" failing client", the underlying CBL clients will be identified and approached by CBL to provide feedback according to the local CSD's requirements.

Consistently and systematically failing clients identification

Annually, CBL identifies "consistently and systematically failing participants" (that is, the CBL client efficiency rate must "at least be 15% lower than the rate of settlement efficiency of the securities

settlement system, during at least a relevant number of days over the 12 previous months") to potentially suspend these clients from settlement.

The following metrics are applied by CBL:

1. CBL settlement system efficiency: The efficiency calculation by number and by value considers all eligible instructions of the previous 12 months with: $100 - (\text{sum of fails} * 100 / \text{sum of eligible instructions})$. Eligible instructions include all matched instructions during the calculation period (that is, matched instructions settled or cancelled on or after ISD. Fails include only matched instructions settled after ISD due to the client's lack of cash or securities or "on hold".
2. Consistently and systematically failing clients: The efficiency calculation by number and by value considers (per client LEI) all eligible instructions of the previous 12 months with: $100 - (\text{sum of fails} * 100 / \text{sum of eligible instructions})$. Eligible instructions include all matched instructions during the calculation period (that is, matched instructions settled or cancelled on or after ISD. Fails for the client's efficiency are restricted to matched instructions settled after ISD due to the single client lack of cash or lack of securities. Instructions cancelled or on-hold after ISD are counted in fails and are included in the number and value of eligible instructions. The number of failing days is the number of business days where the client's efficiency "is at least 15% lower than the rate of settlement efficiency of that securities settlement system, during at least a relevant number of days over the 12 previous months" (the "threshold", that is, the CBL settlement system efficiency rate - 15%). The client's efficiency is computed for every business day, so the computation is restricted to clients below the threshold. The "relevant number of days" is 10% of the number of business days between the reception date of the "oldest" instruction (not just fails) and the reception date of "newest" over the last 12 months. For each client (LEI) below the threshold, the "success rate" by number or value will be calculated.

CBL clients whose fails represent at least 3.5% of the total settlement instructions fails by volume or by value in CBL will be contacted to assess the fail reasons and apply actions to avoid or limit re-occurrence. If the client LEI appears in the CBL-internal "Top 10" failing clients lists of the fourth quarter of the same year as well as in the forthcoming annual "suspension" report, CBL may initiate the actual suspension of the client from settlement after consulting CBL's regulator. The client name as well as the suspension start date will be published in advance. CBL will take the necessary measures to ensure that relevant settlement instructions are blocked from settlement or new instructions received on or after the suspension date can no longer be entered into the CBL system by the suspended client.

This page has intentionally been left blank.

7. Cash Financing Services

CFCL is holding a banking license but it does not act as a payment system or a Cash Correspondent Bank. Clients are therefore reminded that the accounts they open with CFCL should not be used to perform third party payments or any other cash movement not linked to their securities with CFCL.

Without prejudice of any further action under the terms of our General Terms and Conditions, CFCL reserves the right to block and/or to reject any payment either received for credit to a Client account in CFCL or processed from such account, that could qualify as a third-party payment, or where the final beneficiary is not a corporate institution or a financial institution.

For the avoidance of doubt, any payment not linked to any security related service provided by CFCL as described in the Client Handbook is also deemed to be a third-party payment. Furthermore, since only cash transfers are permitted, Clients may not instruct via an MT100 series type message and must use the appropriate MT200 series type message unless CFCL has specifically agreed otherwise.

The services that CFCL provides to Clients for the Settlement are complemented by various services for the management of their cash positions and foreign exchange.

Cash correspondents

For every Settlement currency, at least one Cash Correspondent is appointed to handle the external payment and receipt of funds between the domestic banking system for the currency and CFCL. Details of the Cash Correspondent banks are provided for each market link on the website.

7.1 Cash management and Financing

The cash management services provided by CFCL are available for all currencies accepted in CFCL (unless specified otherwise).

The subjects covered in this chapter are summarised as follows:

- Currencies accepted in CFCL and the network of Cash Correspondent banks, in "[Settlement currencies and Cash Correspondent banks](#)";
- Cash instruction deadlines, in "[Cash instruction processing](#)";
- Cash instruction Types, including "life cycle" diagrams, in "[Cash instruction types - Missed cash deadlines](#)";
- Foreign exchange (FX) services: case-by-case, in "[Foreign Exchange services](#)";
- Financing facilities, including credit lines services, in "[Financing: availability of funds](#)";
- Collateral valuation, in "[Collateral valuation](#)";
- Interest calculation, in "[Interest calculations and reporting](#)".

7.2 Settlement currencies and Cash Correspondent banks

Almost all the currencies accepted in CFCL are Settlement currencies, which can be used to make clean payments and to settle against payment Transactions, irrespective of the currency in which the securities are issued.

Occasionally, CFCL may accept securities for Settlement that are denominated in a non-Settlement currency. In such a case, funds movements in the currency of denomination are not possible in CFCL,

but the securities can be received or delivered against payment in any other CFCL Settlement currency. All currencies are identified by their ISO currency code.

A network of correspondent banks administers external cash Transactions for the various Settlement currencies accepted. The operations carried out by the correspondent banks include the receipt and confirmation of acceptance of funds remitted for credit to Client accounts at CFCL and the execution of payments.

A list of the currencies accepted in CFCL and the relevant correspondent banks is given in the Cash Timings Matrix on the website. A complete list of eligible Settlement and non-Settlement currencies is available on the website.

A complete list of cash instruction input deadlines for all currencies is available in the form of the Cash Timings Matrix on the website. All timings in this matrix are given in CET unless otherwise noted. Cash instruction input deadlines are aligned with local times which means that Clearstream takes daylight saving time (DST) changes around the world into account when setting its CET deadlines.

Consolidated lists of eligible currencies and their domestic market holidays (in the form of the Cash and Securities Holidays matrix) is available on the website.

7.3 Cash instruction processing

Cash deadlines

Currencies are grouped according to instruction deadline, stated in Central European Time (CET) and standard for all communications media.

Clearstream's CET instruction deadlines take daylight saving time (DST) changes around the world into account. Therefore, the cash instruction input deadline will not change in local time but, when seasonal time changes occur in the local market, the CET deadline will automatically adjust in order to maintain a consistent local market deadline.

For instruction deadlines (published in CET only) please refer to the Cash Timings Matrix and the Settlement Timings Matrix on the website.

For a consolidated list of domestic market holidays, please refer to the Cash and Securities Holidays matrix.

Deadlines are published for the entire year and will be updated in October every year. In the interim, any ad-hoc updates to timings will be performed on a case-by-case basis.

Cash repair performed on Client cash instruction

There are two types of cash repair service, defined in the following sections:

- Automatic, which is performed for all Clients and cannot be unsubscribed from;
- Optional, which is performed for Clients whose account is flagged with Cash Repair = Yes.

Note: Optional cash repair is set by default to all CFCL Client accounts, unless explicitly requested by the Client, via Swift or CFS Portal free-format message, to unsubscribe from this service. If the optional cash repair service is unsubscribed, repair services will be disabled in the above-mentioned cases.

1. Cash repair will only be performed on an MT103, MT200, MT202 and MT210 to the extent that the Clients are authorised by CFCL to use this message type for payments from CFCL.
2. Clients are reminded that the requirements of the Funds Transfer Regulation EU 2015/847 must be met at all times and ensure they provide in their instructions, when applicable, the requested information about the payer and the payee. CFCL will not provide any repair service should this information be missing or incomplete. Clients not meeting the requirements of EU Regulation

2015/ 847 may experience late processing or rejection of their instruction by the CFCL Cash Correspondent banks.

Automatic cash repair

Missing Clearstream Fund Centre account number (Swift only).

Upon receipt of a Swift cash instruction with no instructing account specified, the CFCL cash processing system will automatically repair the instruction by substituting for the missing account as follows:

- If a principal CFCL account has been predefined at the Client's request, this principal account will be used.

If the sender of the instruction using CFCL BIC, and if the sender is having only one cash account at CFCL, that account will be used. If no principal account has been predefined, the cash instruction is rejected and the sender automatically notified via an authenticated message.

Note: Clients can predefine a principal account, from among their existing accounts, by sending an authenticated Swift free format message (MT599) for the attention of PPIConnect indicating that they want to define a specific account as the "Principal account for the BIC ABCDEFGHXXX". This account will then be used in reference to the repair of cash instructions via Swift. For securities instructions, the Client should always indicate the relevant account.

Optional cash repair

Missed cash deadlines

Instructions eligible for the automatic cash repair service, described above, are excluded.

Late pre-advices and withdrawal of funds instructions that are subject to the optional cash repair service will be automatically repaired. Instructions that have missed the Client deadline will be accepted for next available processing with next applicable value, the sender is not automatically notified.

If the optional cash repair service flag is set to NO, pre-advices and withdrawal of funds instructions that arrive later than the published deadline for the currency are automatically rejected and the sender is automatically notified via an authenticated message.

Pre-advices without Cash Correspondent details (Swift only)

Swift Pre-advices received with no Cash Correspondent details that are subject to the optional cash repair service will be automatically repaired, as follows:

- Upon receipt of a cash Pre-advise (MT210) where no Cash Correspondent is specified, the cash processing system will, as long as only one Cash Correspondent is appointed for the specific currency, automatically repair the instruction;
- If several Cash Correspondents would be available (for example, for EUR), the Clearstream cash processing system will not be able to repair the instruction.

Pre-advices of funds that cannot be repaired and invalid Pre-advices whose optional cash repair service flag is set to NO will, in each case, be automatically rejected and the sender automatically notified via an authenticated message.

Compliance screening of Client cash instruction

A withdrawal of cash instruction that contains free text in field :72: will be stopped and checked for compliance purposes.

Cancellations and amendments to instructions

Clients cannot amend a cash instruction already sent to CFCL.

Cash instructions can be cancelled and a new instruction sent provided that the cancellation instruction and the new instruction are received before the deadline for the relevant instruction Type (or, in the case of Pre-advice, the earliest deadline for the value date given in the MT210 instruction - Pre-advice of entry of funds). This is only applicable to cancellations fulfilling the automatic process format. Free formatted or non automatic cancellations will be processed on a best effort basis

MT103 or MT200/MT202 instruction - withdrawal of funds cannot be cancelled or amended in the following circumstances:

- If it has been reported as settled; and
- If it has been released for payment.

In these circumstances, the MT103 or MT200/MT202 instruction - withdrawal of funds is considered by CFCL to be irrevocable.

An MT210 Pre-advice of funds cannot be cancelled or amended when it is already settled. In case a settled MT210 Pre-advice of funds is nonetheless subject to a cancellation request, the latter will be reported by CFCL as "rejected" by MT296. A close monitoring is therefore required by the Client for any such cancellation/amendment requests. In the event a cancellation request is rejected unexpectedly, the Client should immediately contact Client Services.

Cancellation of uncovered Pre-advice

For these below-listed CFCL eligible settlement currencies, pre-advice that are not covered just before the currency deadline on the next Business Day following the theoretical value date are automatically cancelled in CFCL.

Charges, as shown in the Clearstream Fund Centre Fee Schedule, are debited to Clients should a cancellation of an uncovered Pre-advice be performed by CFCL.

Please see the following table:

ISO Currency Code	Name	Pre-advice Auto Cancel Days
AED	UAE DIRHAM	1
AMD	ARMENIAN DRAM	1
ARS	ARGENTINE PESO	1
AUD	AUSTRALIAN DOLLAR	3
BGN	BULGARIAN LEV	1
BWP	BOTSWANA PULA	1
CAD	CANADIAN DOLLAR	3
CHF	SWISS FRANC	3
CNY	YUAN RENMINBI	1
CZK	CZECH KORUNA	1
DKK	DANISH KRONE	3
EUR	EURO	3
GBP	POUND STERLING	3
HKD	HONG KONG DOLLAR	3

HUF	FORINT	1
IDR	RUPIAH	1
ILS	NEW ISRAELI SHEQEL	1
ISK	ICELAND KRONA	1
JPY	YEN	3
KRW	WON	1
KZT	TENGE	1
MXN	MEXICAN PESO	1
MYR	MALAYSIAN RINGGIT	1
NOK	NORWEGIAN KRONE	3
NZD	NEW ZEALAND DOLLAR	3
PHP	PHILIPPINE PESO	1
PLN	ZLOTY	1
RON	ROMANIAN LEU	1
RUB	RUSSIAN RUBLE	1
SEK	SWEDISH KRONA	3
SGD	SINGAPORE DOLLAR	1
THB	BAHT	1
TRY	TURKISH LIRA	1
UAH	HRYVNIA	1
USD	US DOLLAR	3
ZAR	RAND	1

Reporting of cancelled cash instructions

Cancelled cash instructions are reported as illustrated below.

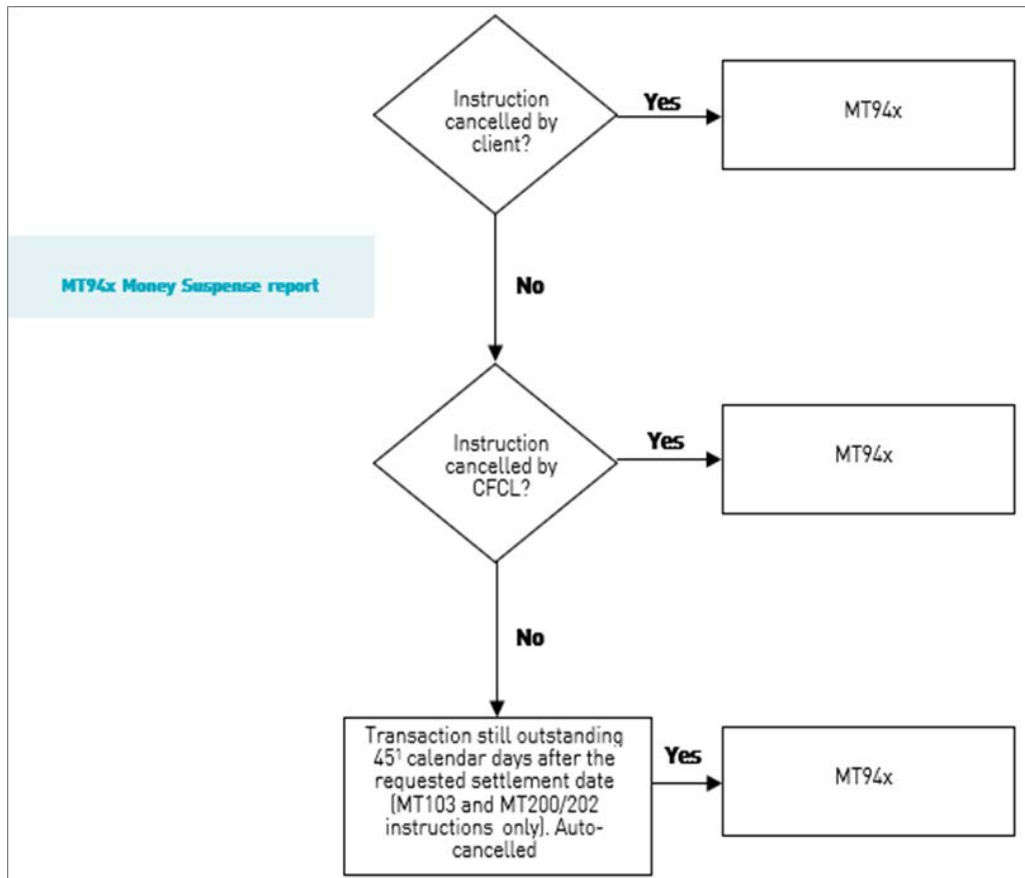

¹ Only applicable to cash withdrawals and transfers.

Figure 7.1 Reporting cancelled cash instructions

7.4 Cash instruction types - Missed cash deadlines

MT210 instruction - Pre-advise of entry of funds

An MT210 instruction from a Client is a Pre-advise of an entry of funds coming from outside CFCL for credit to a Client's CFCL account. Funds are remitted through CFCL's Cash Correspondent bank for the relevant currency.

Pre-advices are sent by Clients to ensure that funds that they have instructed their correspondent bank to pay to CFCL's Cash Correspondent bank for the relevant currency are considered for Settlement purposes, and they will receive the same value once CFCL receives confirmation from its Cash Correspondent bank.

The amount of a Pre-advise must be equal to the amount transferred. If a Client uses a single fund transfer to cover several Pre-advices, the amount transferred will differ from any of the amounts pre-adviced and consequently a late covering charge may be incurred.

If a Pre-advice has been received before the applicable deadline, then funds are credited with good value after confirmation of their receipt with good value by the Cash Correspondent. If pre-advised funds are received after the value date for the Pre-advice, then funds are nevertheless credited with the value date of the Pre-advice but a late covering charge will be incurred.

Funds not pre-advised before the applicable deadline will not be credited with good value. If there is no Pre-advice within the deadline, any funds paid to CFCL's Cash Correspondent bank will be subsequently identified and applied with the first available value date following that of the missed deadline.

Funds expected by book transfer from another CFCL Client (MT103 or MT202 instructions) must not be pre-advised. The same applies to credits such as dividend payments and redemptions orders, which are made automatically by CFCL.

The diagram in [Figure 7.2](#) illustrates the life cycle of an MT210 instruction as described above.

Note: As a general rule, Clients are advised to submit Pre-advice on the basis of the net value of Transactions to be settled in each currency for each Settlement Date (rather than on the basis of individual Transactions).

Non-receipt of pre-advised funds

A Client who pre-advises funds is responsible for ensuring that the funds are paid as advised. CFCL takes all Pre-advice into account in the management of its treasury, thereby enabling Clients to be credited with good value.

Non-receipt, however, adversely impacts CFCL's actual funds positions with Cash Correspondents and, for this reason, CFCL may, at its discretion, levy a penalty debit interest charge on pre-advised funds that have not been received. Clients should therefore ensure that pre-advised funds are actually paid, even if they discover after sending the Pre-advice that sufficient funds are already available on their account.

For cancellations, see "[Cancellations and amendments to instructions](#)".

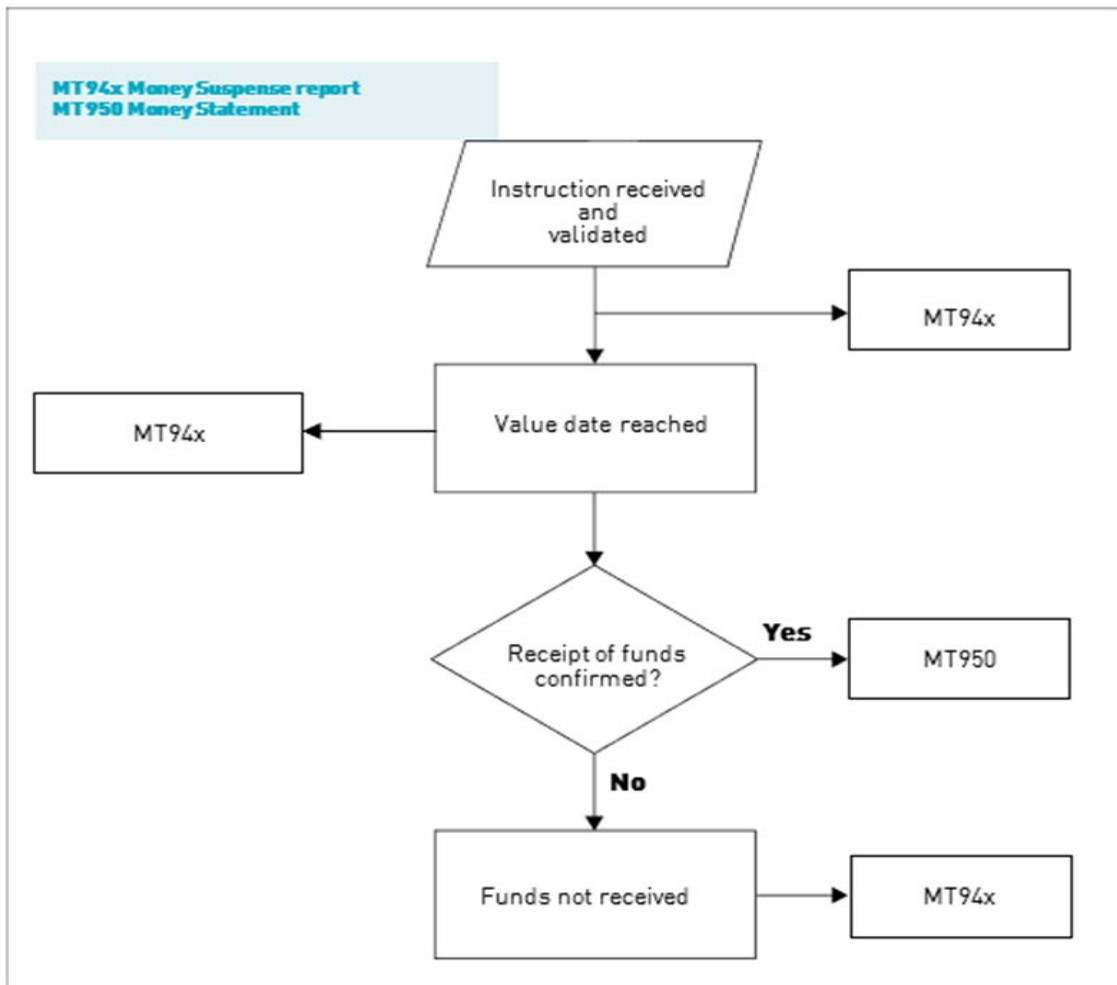

Figure 7.2 Life cycle of an MT210 instruction (Pre-advice of entry of funds)

MT103 or MT200/202 instructions - Withdrawal of funds

An MT103 or MT200/202 instruction is a withdrawal of funds from the Client's CFCL account for payment outside CFCL. A withdrawal of funds via MT103 is only allowed if the Client is authorised by CFCL to use this message type for payments from CFCL.

Execution of the cash instruction is conditional on a cash Settlement Provision check on the Client's account.

MT103 or MT200/202 instructions are processed by the CFCL correspondent bank on the Business Day corresponding to the value date in the country of the relevant currency. If the value date requested is a Business Day in CFCL, but not in the country of the currency of payment, funds will be paid with the next available value date.

Clients are reminded that CFCL will process payments only related to securities Transactions and corporate events. Furthermore, CFCL will not process payments when it identifies that the final beneficiary is not a financial institution.

Clients are reminded that the requirements of the Funds Transfer Regulation EU 2015/847 must be met at all times and ensure they provide in their instructions, when applicable, the requested information about the payer and the payee. CFCL will not provide any repair service should this information be

missing or incomplete. Clients not meeting the requirements of EU Regulation 2015/847 may experience late processing or rejection of their instruction by the CFCL Cash Correspondent banks.

To determine whether a BIC (Bank Identifier Code) corresponds to a qualifying financial institution, Clients should check the category of participant (please refer to paragraph 9 of the preface to the white pages of the BIC Directory). Some of the categories relate to financial institutions and others to non-financial institutions (please refer to the yellow pages of the BIC Directory). Some categories of non-financial institutions are: TRCO; BEID; MCCO; and TESP.

Other categories have restricted access to Swift services and Clients will find the restrictions in the FIN matrix restrictions. A non-connected BIC not belonging to the above listed categories is considered a financial institution. For an exhaustive list of codes, please refer to the latest BIC Directory.

Clients are reminded of the importance of using BICs whenever possible for payment details (fields Pay to, For account of and In favour of). If no BIC exists to identify a party, all possible information (bank's full name and city) should be used to identify it.

For EUR withdrawals of funds, CFCL applies a better cash deadline if the EUR withdrawal of funds instructions are STP. To be considered STP, an instruction must follow the format below:

- The Ordering Institution BIC is equal to the Beneficiary Institution BIC;
- Fields that correspond to the payment parties contain a published BIC (no account number should be input in these fields);
- No narrative fields are present.

CFCL reserves the right to amend the above-mentioned criteria at any given time with notice to its Clients.

Any EUR withdrawal of funds instructions that do not follow this format will be considered as non-STP.

The diagram in [Figure 7.3](#) below illustrates the life cycle of an MT103 or MT200/202 instruction as described above.

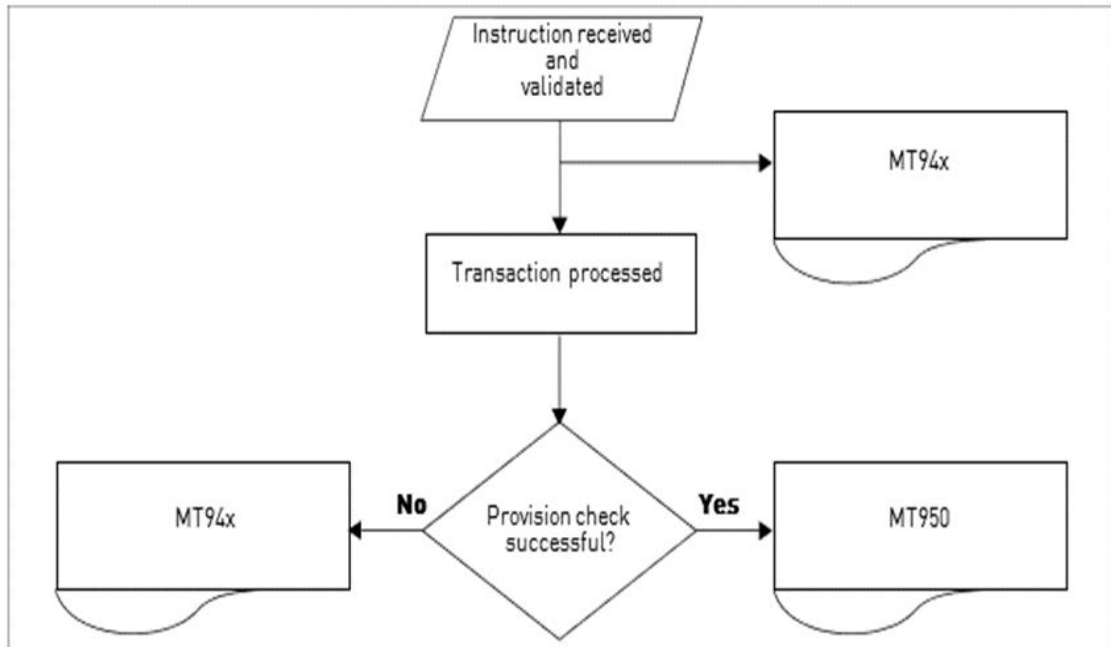

Figure 7.3 Life cycle of an MT103 or MT200/202 instruction

Withdrawals of funds in currencies ARS, AMD, BGN, CAD, CHF, CZK, DKK, EUR, GBP, HUF, ILS, ISK, KZT, MXN, NOK, PLN, RON, RUB, SEK, TRY, USD and ZAR are processed from the first available processing for the value date (and continuously thereafter).

- Withdrawals of funds in currencies AED, AUD, BWP, CNY, HKD, IDR, JPY, KRW, MYR, NZD, PHP and SGD are first processed at the end of day on the Business Day before the value date and on real-time processing for withdrawals on the value date. Exception: Payment instructions received via MT103 in JPY and NZD will not be processed for same day value in the real-time processing.
- Withdrawals of funds in currencies and THB are processed at the end of day, on the Business Day before the value date.

For cancellations, see "[Cancellations and amendments to instructions](#)".

Foreign Exchange (FX)

An MT380 instructions is provided to request currency conversion in a standardised format.

MT380 Tag	MT380 field name	CBS field name	Options / Comments
20C	Sender's Reference	Transaction Reference Number	This field contains the sender's unambiguous identification of the transaction. Its detailed form and content are at the discretion of the sender.
23G	Function of the Message	NEWM/DUPL	NEWM: This is a new order to buy or sell DUPL: the message is for information/confirmation purpose. It is a duplicate of a message previously sent
95a	Investor	Customer	This field must be automatically populated by the CBS based on the account number provided.
98a:ORDR	Date/Time	Order date	The field must be automatically populated from the order date contained within the API call.
98a	Date/Time	Order time	The field must be automatically populated from the system time at order reception
22H	Buy/Sell Indicator	Operation Type	-
19B	Ordered Amount	Order-Currency	-
19B	Ordered Amount	Order-Amount	-
97A	Safekeeping Account	Order currency - Account	This will be the account specified in the FX instruction request

11A	Counter Currency	Counter-Currency	-
98a:RVAL	Date/Time	Value Date	<p>Clients requesting a value date before the default spot date will have their instructions defaulted to a T+2 value date</p> <p>Clients requesting a value after the default spot date will have their instructions put on hold until two days before the requested value date</p>

An MT380 and MT299 instruction is provided to request currency conversion in a standardised format.

An MT380 and MT299 and instruction (for the attention of Forex) is used to instruct an FX Transaction on a case-by-case basis (not automatic). The Client will define the currency and amount to convert and indicate both the buy and the sell currencies. The FX request must be for the Client's own CFCL account.

Example FX instruction:

Account	12345	
Amount/ Currency	1,000,000.00	USD
Action buy/ sell	buy	Customer
Requested value date	30.10.2023	Order date
Counter currency	Date/Time	EUR

The instruction deadline for this type of service is two Business Days before the requested value date (VD-2), timing depending on the currency. The FX instruction will first undergo a credit and collateral provision check. After the deadline, CFCL effects the FX Transaction and debit instructions are generated. Pending instructions are reported in the MT94x (Money Suspense Report). On value date, a credit and debit are posted to the Client's account and reported in the MT950 (Money Statement).

An MT380 and MT299 instruction, once sent, must be considered as irrevocable (unless rejected during the validation process) and cannot be cancelled.

Note: More detailed information about the FX Service is provided in Foreign Exchange services.

The diagram in [Figure 7.4](#) below illustrates the life cycle of an MT380 and MT299 instruction as described above and should be viewed in conjunction with [Figure 7.6](#).

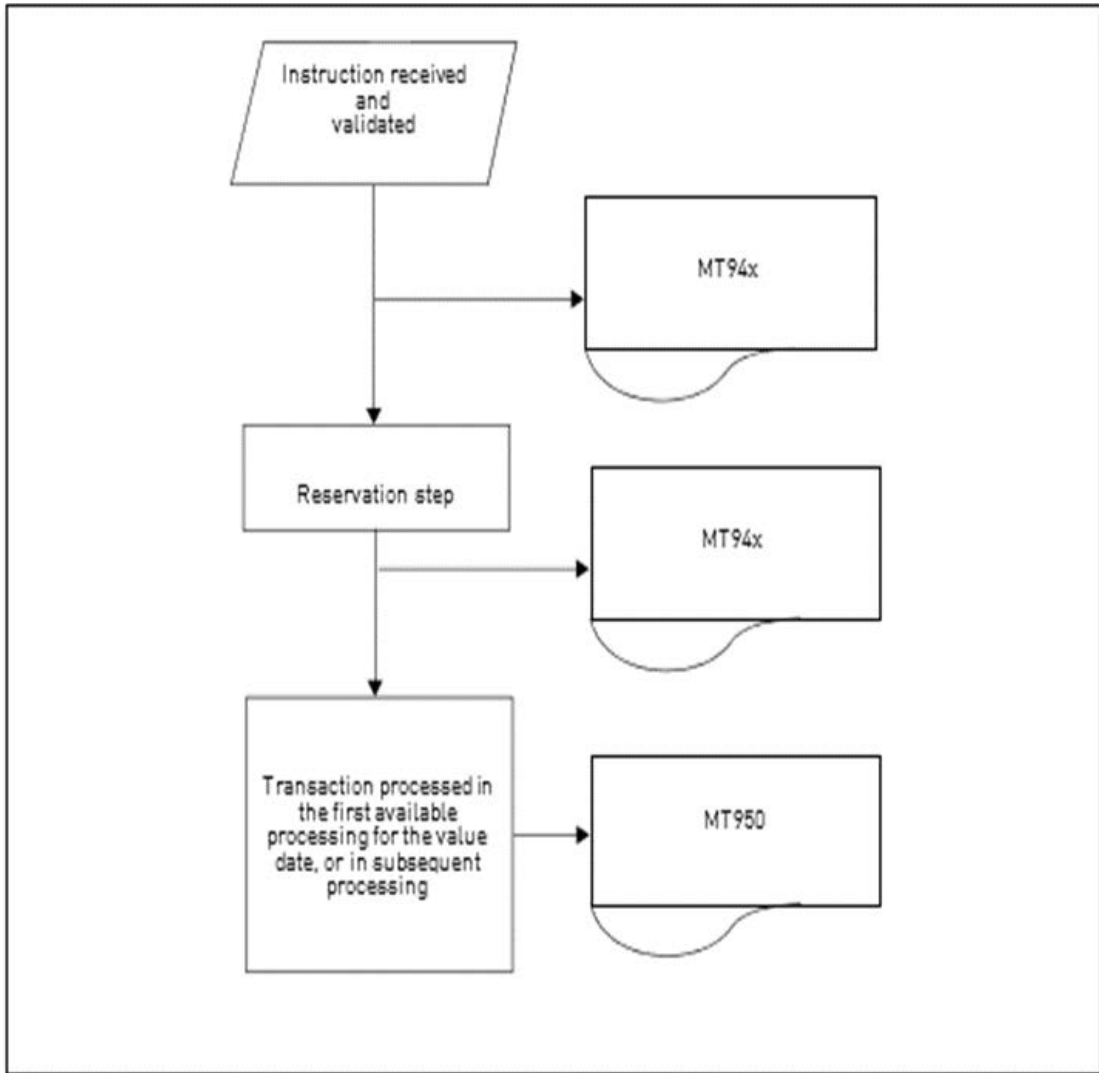

Figure 7.4 Life cycle of a foreign exchange instruction

MT103 or MT202 instruction - Book-entry transfer of funds

Clients must use an MT103 or MT202 instruction to transfer funds from one CFCL account to another. These transfers are in Confirmed Funds. A book-entry transfer of funds will create simultaneous entries on both debit and credit accounts. These entries are reported via MT940, with the related life cycle status, immediately upon receipt of a valid transfer instruction.

Only the Client requesting the payment should submit an MT103 or MT202 instruction, by means of which the beneficiary's account will automatically be credited. The beneficiary must not pre-advise funds to be received by book-entry transfer. An invalid transfer instruction will be rejected to the instructing party only.

Note: The value date applied to MT103 or MT202 instructions is the Settlement Date of the processing. The MT103 or MT202 instruction is not available for book-entry transfer of funds with back value.

For cancellations, see "[Cancellations and amendments to instructions](#)".

The diagram in [Figure 7.5](#) below illustrates the life cycle of an MT103 or MT202 instruction as described above and should be viewed in conjunction with [Figure 7.6](#).

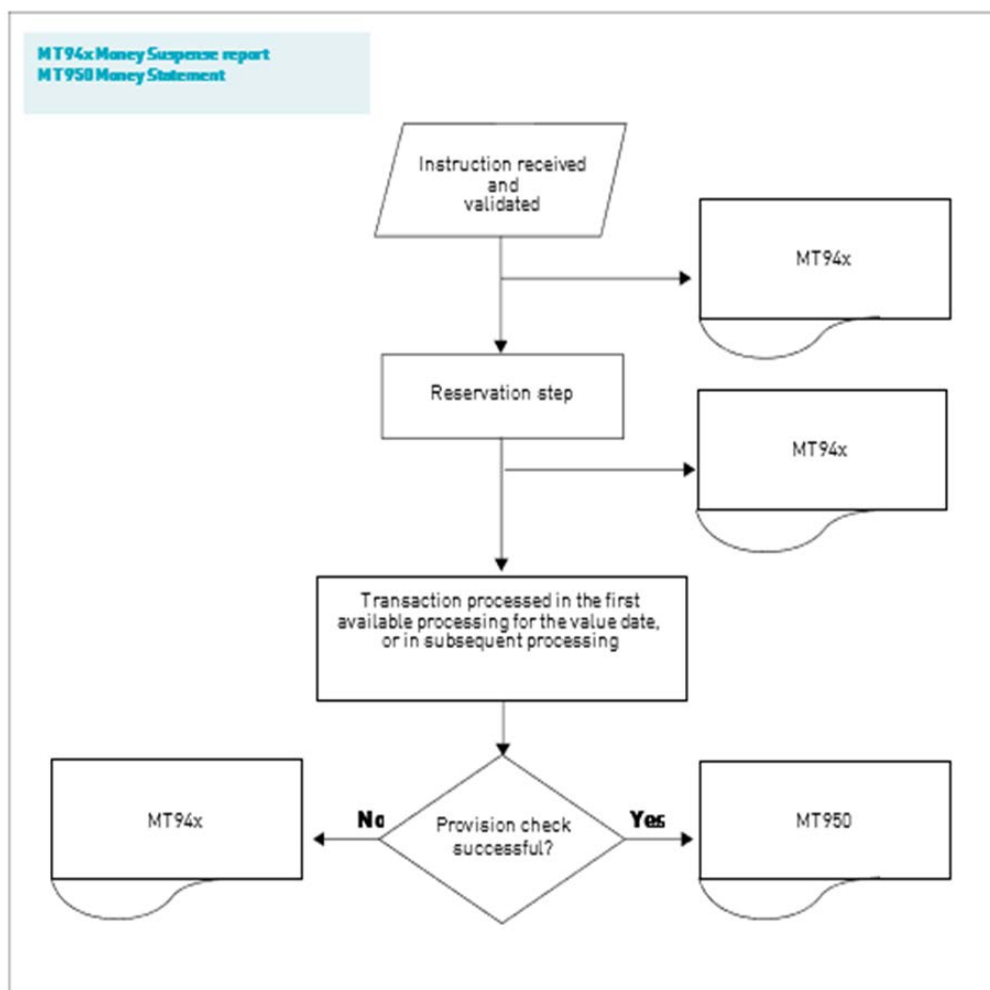

Figure 7.5 Life cycle of an MT103 or MT202 instruction

7.5 Foreign Exchange services

CFCL offers the following Foreign Exchange (FX) services:

- Case-by-case FX service.

For CFCL to process FX instructions, the Client must either have sufficient cash on its account or sufficient credit facility from the Trade Date, which is two Business Days before value date (VD-2).

Communications media

Clients can use the services via the following communications media:

- Case-by-case

Clients must submit FX instructions using any of the following media, CFS Portal entry form or send a Swift MT380, MT299 or MT599 for the attention of Forex.

Overview of FX Processing

The following figure represents the life cycle of an FX instruction:

- On Trade Date when a valid instruction is input, it will be checked against cash and credit availability.
- As a result, the required cash amount is reserved based on a provisional rate.
- This reservation attempt is made once a day for three (3)¹ consecutive Business Days.
- If none of the three (3) attempts is successful, then the FX instruction will be rejected.

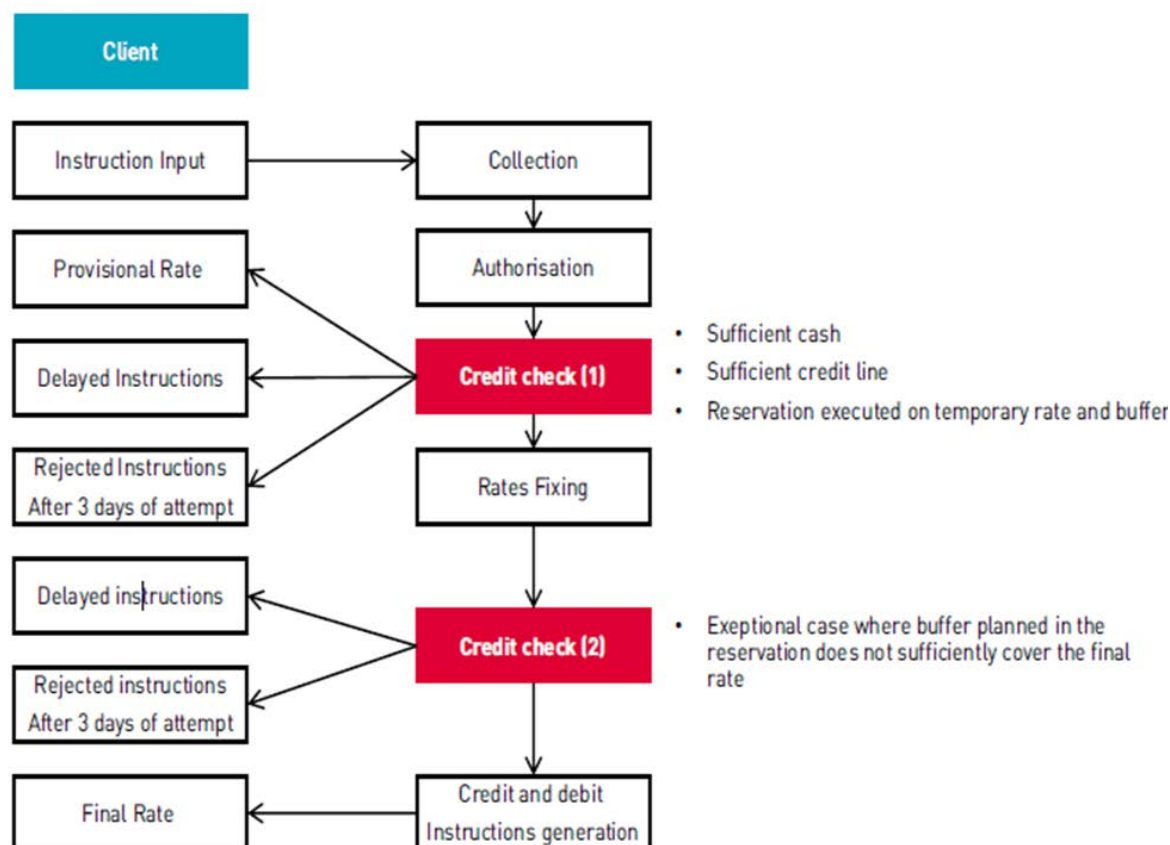

Figure 7.6 Life cycle of FX processing

Case-by-case FX service

The case-by-case FX (foreign exchange) service allows Clients to arrange, for a specific event, the conversion of cash Balances or income proceeds into a currency of their choice.

The case-by-case FX service is available for an FX between two currencies eligible for this service (for the complete list of currencies eligible please see FX services offered, per currency).

Using the case-by-case FX service

To effect an FX Transaction using the case-by-case FX service, Clients must send their FX instruction via one of the following media, a Swift MT380, MT299 or MT599 instruction Type (for the attention of Forex) or an CFS Portal free format message.

1. Three days is the total number of days for credit check (1) and credit check (2).

The instruction deadline for the case-by-case FX service is 11:15 CET two Business Days before value date (VD-2), except for the following currencies: IDR, MYR, and THB. The Client can input instructions at any time up to the 11:15 deadline (VD-2) described above.

The currencies are converted according to spot market procedure for value date two Business Days later (except for a currency holiday, in which case the next possible conversion date will be used).

The FX request must be for the Client's own account. The Client defines the Buy and Sell currency and the amount to be converted up to a maximum of EUR 10,000,000 or the equivalent in another currency:

Buy currency: Currency that will be credited to the Client's account. Sell currency: Currency that will be debited from the Client's account.

To effect an FX Transaction exceeding the EUR 10,000,000 or its equivalent in another currency Clients must either:

- Submit several instructions in the system for lower amounts, or
- Telephone CFCL Client Services immediately upon receipt of the rejection message, to confirm the FX request and amount. Clients must then submit as written confirmation, a Swift MT299 Instruction Type (Attn: Treasury Back Office).

Provided the applicable deadlines have been met and based on the usual credit approval the FX instruction will still be executed with good value. In case of receipt of the confirmation after the deadline, the FX instruction will be executed with good value on a best-efforts basis, but with a different FX rate from the daily CFCL foreign exchange fixing rate.

Once an instruction is sent, it must be considered as irrevocable unless rejected during the validation process and cannot be cancelled. Manual cancellation might be possible on request, on a "best efforts" basis, if the FX instruction has not yet been executed at that stage.

Note: Clients need nevertheless absolutely to recheck with their Client Services Officer the status of the FX instruction (already rejected, suspended, valid but not yet executed or executed) before sending a reverse FX instruction.

Reporting

Pending FX instructions are reported in the MT94x (Money Suspense report). Book-entry movements are reported in the MT950 (Money Statement). FX instructions related to the case-by-case FX service are identified by a FEX code plus an initial prefix which recognises the type of the message:

- A first advice (F)
- A non Swift message (N)
- A Swift message (S)

Example, MT380 Instruction message will be "SFEX".

Additional information on the FX services

Exchange rates

Provisional rate

On Trade Date when a valid instruction is input, it will be checked against cash and credit availability and the required cash amount is then reserved based on a provisional internal rate.

Final rate

Once reservation is successful, a final provisioning will take place with the final rate.

The FX rates obtained for a conversion are indicated in the narrative field of the MT210 and MT103, MT200/202 instructions that accompany the details of the Transaction.

All FX rates are published daily via the [Clearstream Codelist application](#) at around 16:30 each Business Day.

The official FX rates are communicated via Swift MT210, MT103, MT200 and MT202.

The FX rates published via the [Clearstream Codelist application](#) are only informative and shall not be used as an official reference.

The FX rates fixed are as quoted in the foreign exchange market against the EUR and apply to both buy and sell instructions. The fixing process is handled between 15:00 and 16:00 CET.

Any exception to this rule is outlined in the section "[FX services offered, per currency](#)". For FX instructions of currency pairs where the EUR is not part of the pair, the system calculates a cross rate using the fixed rates against the EUR.

Withdrawal of converted funds

Instructions to withdraw funds resulting from a FX Transaction are subject to the normal deadlines for each currency.

Suspension of FX services

CFCL may temporarily suspend and/or cancel any outstanding FX service instruction if circumstances do not permit orderly trading and/or trade execution. In this event, CFCL will notify Clients as soon as possible.

Refusal of an FX instruction

CFCL may refuse an FX service instruction if it has been rejected during the validation process.

CFCL holidays and currency holidays

If the conversion value date falls on a day that is not a Business Day for CFCL and/or for the original or resulting currency, the next possible value date will be used. Clients are recommended to consult a currency holiday schedule before submitting an FX instruction. No FX instruction will be handled on an EUR holiday and, as a consequence, FX instructions sent after the FX instruction deadline on the day before an EUR holiday (or on the day of an EUR holiday itself) will be delayed and executed with the next possible value date.

FX services offered, per currency

Eligible currencies for the, case-by-case FX services are shown below. The list of eligible currencies may be modified at any time without prior notification by CFCL depending on market conditions.

Eligible currencies for the, case-by-case FX services are shown below. The list of eligible currencies may be modified at any time without prior notification by CFCL depending on market conditions.

Currency	FX service offered	Restrictions or special handling details?
AED	Sender's Reference	Transaction Reference Number
AMD	Function of the Message	NEWM/DUPL
AUD	Investor	Customer
BGN	YES	NONE
CAD	YES	NONE
CZK	YES	NONE
DKK	YES	NONE
EUR	YES	NONE
GBP	YES	NONE

HKD	YES	NONE
HUF	YES	NONE

Currency	FX service offered	Restrictions or special handling details?
IDR	YES (limited)	YES

IDR is ineligible for Automatic FX services. For all other FX services, Clients must provide a broker securities trade confirmation along with the FX instruction before the IDR FX deadline. Clients must adhere to the following requirements:

- Include details of underlying trades or corporate action reference (EXRI CORP ID, instructed quantity, and subscription cost value) in the optional wording field of the FX instruction.
- The purchased IDR amount cannot exceed the securities trade or corporate action instruction settlement amount but may be less.
- A buy IDR FX instruction's value date must be on or before the settlement date of the underlying trade or corporate action instruction.
- A sell IDR FX instruction's value date must be on or after the settlement date of the underlying trade or corporate action instruction.
- The underlying securities settlement instruction or corporate action must be received before executing the FX transaction.

Failure to comply may result in delayed FX request settlements.

Note: Buy IDR FX instructions can cover domestic Securities purchases (61) or charges on CFCL accounts, while non-domestic Securities purchases (41) are subject to Indonesian Central Bank restrictions. CFCL can execute buy IDR FX instructions unrelated to a domestic Security purchase if the Client's counterparty sends a sell IDR FX instruction for the respective non-domestic Security sale (51).

Special deadline: 07:45 CET wintertime (VD-1)/ 08:45 CET (VD-1) summertime, subject to a threshold limit of IDR 50 billion.

Instructions received after this deadline will be executed with the requested value on a "best efforts" basis only.

Note that:

- FX instructions sent via the CFS Portal may benefit from the above instruction deadline only if the value date T+1 is requested in the requested value date;
- Free format instructions sent via Swift MT299 may benefit from the above instruction deadline if the value date T+1 is clearly requested. For instructions above the threshold limit or received after the instruction deadline, CFCL executes the FX operation according to spot market procedures and on a "best efforts" basis;
- Instructions sent via Swift MT380 may benefit from the above instruction deadline if the value date T+1 is clearly requested. For instructions above the threshold limit or received after the instruction deadline, CFCL executes the FX operation according to spot market procedures and on a "best efforts" basis.

As CFCL must square FX positions with the CCB directly, FX instructions sent on the day the currency is closed (or received after the FX instruction deadline on the preceding Business Day) may be delayed and the requested value date cannot be guaranteed.

Currency	FX service offered	Restrictions or special handling details?
ILS	YES	NONE
ISK	YES	Swift MT299/MT599 instruction; only case-by-case FX service.
JPY	YES	NONE
KZT	YES	NONE
MXN	YES	NONE

Currency	FX service offered	Restrictions or special handling details?
MYR	YES (limited)	YES

Buy and Sell FX instructions are possible under the condition that prior to instructing, the Client must send an MT599 to the attention of Treasury Backoffice, stating the following: "Attn: Clearstream Fund Centre Treasury Backoffice. Clearstream Account Number: Clearstream account(s) number(s).

We, (entity name), hereby unconditionally represent and warrant that we do not and will not conduct or transact in any offshore MYR non-deliverable forwards and / or offshore MYR foreign exchange derivatives contracts, as well as any future product of financial instruments of similar substance.

We, (entity name), agree to indemnify Clearstream Fund Centre and to hold Clearstream Fund Centre harmless for any claims, fines, penalties, damages or losses, whether direct or indirect, resulting from an untrue, incomplete or inaccurate representation." Once the MT599 is recorded with CFCL Treasury Backoffice, then the following rules apply to MYR currency for FX instructions:

Sell MYR FX instructions are possible if there are sufficient funds on the CFCL Client account at the FX instruction deadline.

If the Balance is not sufficient, sell MYR FX instructions related to securities sales will be suspended until the securities sale has settled. Sell MYR FX instructions exceeding MYR 10,000 directly linked to a securities instruction (FX instruction directly set on the securities instruction) will be suspended until the securities instructions has settled. Depending on the agreement from the agent in Malaysia, the FX will then be executed with good value.

N.B.: Same-day FX is only possible where an underlying domestic sell securities trade has settled on that day. Sell FX instructions sent for a value date different from that of the relating securities instruction may be delayed and executed with another than requested value date.

If the Client sends buy and sell MYR FX instructions for the same value date, CFCL will execute the buy instruction first to unblock the securities purchase and will suspend the sell FX instruction until the Balance on the CFCL Client account is sufficient to execute the FX. Depending on the agreement from the agent in Malaysia, the FX will then be executed with good value but with a different FX rate than that of the buy FX instruction.

FX instructions for amounts less than or equal to MYR 10,000 may nevertheless, if CFCL Treasury estimates that the CFCL overall liquidity position with the agent in Malaysia allows it to do so, be executed immediately without awaiting the securities Settlement or the available Balance.

Special deadline: 09:45 CET (VD-1) wintertime / 10:45 CET summertime. (VD-1), subject to a threshold limit of MYR 8 million.

Instructions received after this deadline will be executed with the requested value on a "best efforts" basis only.

Note that:

- FX instructions sent via the CFS Portal may benefit from the above instruction deadline only if the value date T+1 is requested in the requested value date;

Free format instructions sent via Swift MT299 may benefit from the above instruction deadline if the value date T+1 is clearly requested. For instructions above the threshold limit or received after the instruction deadline, CFCL executes the FX operation according to spot market procedures and on a "best efforts" basis.

- Instructions sent via Swift MT380 may benefit from the above instruction deadline if the value date T+1 is clearly requested. For instructions above the threshold limit or received after the instruction deadline, CFCL executes the FX operation according to spot market procedures and on a "best efforts" basis.

As CFCL must square FX positions with the CCB directly (CBL), FX instructions sent on the day the currency is closed (or received after the FX instruction deadline on the preceding Business Day) may be delayed and the requested value date cannot be guaranteed.

Currency	FX service offered	Restrictions or special handling details?
NOK	YES	NONE
NZD	YES	NONE

Currency	FX service offered	Restrictions or special handling details?
PHP	YES (limited)	YES

Swift MT380 and MT599 and portal instructions; only case-by-case FX service.

Only restricted sell PHP FX instructions are allowed.

Only custody proceeds resulting from securities with a Bangko Sentral Registration Document (BSRD) can be requested for FX. The exact details clearly mentioning the origin of the funds must be set on the FX order.

When completing its FX instruction, the Client must strictly comply with the procedure as described in the Link Guide - Philippines under "Foreign exchange and repatriation of income proceeds".

Clearstream Fund Centre Luxembourg will forward the details with the FX request to the agent in the Philippines. Upon his reply, the FX will be executed with best possible value date.

Buy PHP FX instructions may be accepted in very exceptional circumstances (for example, if CFCL's own PHP currency FX position would allow CFCL to satisfy the Client request).

Before sending such an instruction, the Client must first verify, with his Relationship Officer or with CFCL Treasury, that it will be accepted.

As CFCL must square FX positions with the CCB directly, FX instructions sent on the day the currency is closed (or received after the FX instruction deadline on the preceding Business Day) may be delayed and the requested value date cannot be guaranteed.

Currency	FX service offered	Restrictions or special handling details?
PLN	YES	NONE
RON	YES	NONE

SEK	YES	NONE
SGD	YES	NONE

Currency	FX service offered	Restrictions or special handling details?
THB	YES (limited)	YES

Forced FX:

If the overall Clearstream THB Cash Balance at the Cash Correspondent Bank in Thailand exceeds the maximum regulatory amount, Clearstream will be forced to do a same-day FX at a penalty FX rate in order to reduce the balance. This forced FX will be booked, without prior advice, to the Client accounts presenting the largest balances. The FX will consist of a sale of THB against USD value D at a penalty FX rate, fixed by the Bank of Thailand. These operations may be repeated as often as necessary.

Measures to avoid forced FX:

- CFCL Clients are advised to be extremely careful to keep their THB Balances at the lowest practicable levels.
- CFCL Clients are requested to match value dates of FX instructions and security instructions.
- If the Client sends buy and sell THB FX instructions for the same value date, CFCL will execute the buy instruction first to unblock the securities purchase and will suspend the sell FX instruction until the money is as confirmed balance on the account. Depending on the agreement from the agent in Thailand, the FX will then be executed with good value but with an FX rate other than that on the buy FX instruction.
- Clients should take care that they send buy THB FX instructions only if they need THB on their account to cover securities purchases or charges on their CFCL account.
- For internal trades (41/51) with related FX instructions from both buyer and seller, CFCL will, in order to avoid the overall balance at the CCB exceeding the regulatory maximum amount and a partially forced FX being performed with a penalty FX rate, execute both FX instructions at the same time.

Special deadline: 09:45 CET (VD-1) wintertime / 10:45 CET (VD-1) summertime, subject to a threshold limit of THB 30 million.

Instructions received after this deadline will be executed with the requested value on a "best efforts" basis only.

Note that:

- Portal instructions sent in CFS Portal may benefit from the above instruction deadline only if the value date T+1 is requested in the requested value date;
- Free format instructions sent via Swift MT299 may benefit from the above instruction deadline if the value date T+1 is clearly requested. For instructions above the threshold limit or received after the instruction deadline, CFCL executes the FX operation according to spot market procedures and on a "best efforts" basis.
- Instructions sent via Swift MT380 may benefit from the above instruction deadline if the value date T+1 is clearly requested. For instructions above the threshold limit or received after the instruction deadline, CFCL executes the FX operation according to spot market procedures and on a "best efforts" basis.

As CFCL must square FX positions with the CCB directly, FX instructions sent on the day the currency is closed (or received after the FX instruction deadline on the preceding Business Day) may be delayed and the requested value date cannot be guaranteed.

Currency	FX service offered	Restrictions or special handling details?
TRY	YES	NONE
UAH	YES	YES
USD	YES	NONE
ZAR	YES	NONE

7.6 Financing: availability of funds

Cash financing service provided by CFCL

The purpose of the CFCL credit facility is to facilitate the clearance of securities transactions against payment. It is also used for the settlement of Client FX trades.

The terms governing the CFCL credit facility are described in the Credit Terms and Conditions (CTCs), Client Application Form and Annexes signed by Clients before the facility is made available.

Characteristics of CFCL Credit Facility

The principal characteristics of the CFCL credit facility are as follows:

- It is an intraday credit line made available for the purchase of securities at the start of the settlement day against covering funds to be confirmed by the end of real-time processing on value date. The time limit applies at two levels:
 - To individual currencies;
 - To the overall net positions across all debit and credit Balances on the accounts, through CFCL's right of set-off.
- Debit positions must not continue beyond the end of real-time processing on value date. Technically, a currency or the account may be blocked from the start of the third settlement day if either the individual currency overdraft or the overall net overdraft Balance on the account (offsetting debit and credit Balances in each currency) is not repaid within that timeframe, either by proceeds from against payment deliveries or by pre-advised funds.

Note: Any overnight borrowing will be subject to debit interest rates that are subject to a yearly review.

- The value of every currency overdrawn, or drawn, under the terms of the facility is revalued in USD on a real time basis and compared against the value of available Collateral on the Client's account. Only the amount actually drawn needs to be collateralised.
- The agreed credit limit is fixed in USD, but can cover other currencies as described in [Figure 7.7](#). The exchange rate used is determined daily by CFCL. "It applies to only one account. Separate applications must be made for overdraft facilities that apply to other accounts of the same Client.
- The credit facility size depends on the financial standing of the Client in whose name the account is opened. It can be cancelled unconditionally, at any time, without previous notice. CFCL may also suspend the credit facility for any given currency, at any time, without previous notice.
- Any change to the agreed CFCL credit limit will be communicated via electronic authenticated message (via Swift or other secured communication method) or via non-electronic authenticated message accepted by CFCL.

Eligible currencies

The following currencies are eligible to use Credit facilities:

AUD	CAD	CHF	CNY	EUR	GBP
HKD	JPY	NOK	SEK	SGD	USD

Figure 7.7 Currencies eligible to use Credit facilities

Umbrella Credit Services (UCS)

Umbrella Credit Services (UCS) are CFCL services available to facilitate Client's credit management requirements. The services provide an umbrella credit line at Client level, that is, accessible from any account the Client has with CFCL, considering that the client will use Fixed Income collateral.

In addition to CFCL providing global credit lines on individual accounts, an umbrella credit line is accessible from any account the Client has with CFCL behaviours.

Each individual account linked to an umbrella will be able to share credit lines.

The monitoring of both the credit line throughout participating accounts and of the available Collateral are fully automated.

For more details on CFCL's UCS please contact Clearstream Client Services or your Relationship Officer.

How to arrange Umbrella Credit Services (UCS)

Clients who would like to arrange UCS facility must apply in writing to their Client Services Officer or Relationship Officer stating the account number and the amount of the credit line required in USD. The latest available annual report or audited financial statements, including an income statement and balance sheet, must also be provided.

When an application for a credit line on a standalone account or a UCS facility is approved, the Credit Terms and Conditions, Client Application Form and Annexes are forwarded in duplicate to the applicant for signature. This document must be endorsed with authorised signatures. One copy of the Credit Terms and Conditions, Client Application Form and Annexes is returned to the Client's Client Services Officer or Relationship Officer and the other is kept by the Client.

A credit line under standalone account or UCS facility is only implemented after CFCL receives the properly completed agreement(s) and sends the Client an authenticated message confirmation.

7.7 Collateral valuation

CFCL together with CBL as its custodian of assets has a general right of retention and set-off on all assets held on the Client's CBL account that secure obligations towards CFCL by the Client for the services rendered. All assets held by the Client in CBL are pledged in favour of CFCL to the extent of any credit facilities granted to the Client.

CFCL offers Clients one way to allocate collateral to be used for their credit line usage: securities.

For Fixed Income securities used as collateral, CFCL uses the triparty collateral management services of CBL - Cmax - to manage exposure.

The collateral value of the Fixed Income securities on the Client's account must at all times be equal to, or greater than, the total value of all obligations that CFCL undertakes on behalf of the Client.

The enforcement of any pledge granted in favour of CFCL pursuant to its Governing Documents or other Client documentation is carried out in accordance with such documentation and (unless otherwise agreed) by Luxembourg law, it being understood that such enforcement methods may be carried out alternatively or cumulatively. Unless expressly agreed otherwise, if such enforcement is carried out by:

- Sale, CFCL will determine the price by selecting and accepting in good faith offer(s) for any collateral determined by CFCL to be liquidated. This sale can be organised by selling such assets in a private sale at normal commercial terms, in an organised sale or in a public sale (whether or not, at CFCL's discretion, made by or through a stock exchange).

The value of the pledged collateral will be the price obtained in such sale.

- Appropriation, such appropriation will be made at the value determined by CFCL at its absolute discretion and acting in good faith, or by any neutral third party appointed by CFCL, or any other pricing information services selected by CFCL, each time selected by CFCL at its sole discretion for the purposes of making or assisting it in making such determination, considering inter alia any listed price (if any), any published net asset value (if any), the respective market spreads, and any liquidation impacts. Such determinations shall be binding on the Client absent manifest error.

For the avoidance of doubt, such determination process can be carried out before or after the appropriation. The value of the pledged collateral will be determined as at the date of the appropriation. The value of the pledged collateral will be the one so determined. CFCL may elect, in its sole discretion, to appoint another person to which the right to appropriate the pledged collateral shall be transferred in lieu of CFCL, it being understood that such appointment shall not affect CFCL rights and obligations against the relevant pledgor.

CFCL shall be indemnified by the Client on first demand against all legal, administrative or other costs, expenses and fees which CFCL may incur in preserving, enforcing or obtaining its rights, or attempting the same, as well as any costs, expenses and fees (including legal fees) relating to the enforcement of any pledge granted in favour of CFCL pursuant to its Governing Documents or other Client documentation.

Eligibility of securities

The eligibility of Fixed Income collateral to be pledged when using Credit facilities from CFCL will be determined by CFCL and enforced through CBL since CFCL will outsource Collateral services to its sub-custodian Clearstream Banking Luxembourg (CBL).

CBL through CmaX will ultimately decide whether a security is accepted as collateral. The security rating and the conditions of the security, such as the size of the issue, its currency of denomination, its special characteristics, its liquidity or its volatility may be decisive factors in accepting a security as eligible for collateral. The fact that a Fixed Income Instrument is not accepted as collateral should not necessarily be taken as an indication that the paper is of poor or doubtful quality.

In order to be able to pledge securities as collateral for CFCL credit line, CFCL Clients are required to be onboarded in CBL as CmaX collateral givers.

For more information about CBL Collateral management process through CmaX, please check the [CBL Client Handbook](#) or contact your relationship management officer.

Collateral eligibility criteria

Collateral eligibility criteria Clearstream Banking decides whether a Security is eligible as Collateral. From a risk perspective, Clearstream Banking can unilaterally modify the Collateral Eligibility Criteria from time to time, thus taking into account potential changes to the market conditions. Criteria such as the instrument type, issue characteristics, Issuer country, industry sector, currency denomination and the Issuer rating are used to determine whether a Security is to be accepted. The Collateral Eligibility Criteria used in the Programme are as follows:

- Rating for Government, Sovereign, Supranational and Agency long-term Fixed Income Securities above or equal to A+; Exceptionally, for Eurozone Government and Sovereign debt, a rating of A and above is accepted.
- Rating for long-term Corporate Fixed Income Securities above or equal to A+;
- Rating for Covered Bonds above or equal to AA;
- Rating for short-term Fixed Income Securities above or equal to A1;
- Term to maturity less than/equal to 30 years for government, sovereign, agency and supranational Fixed Income Securities;
- Term to maturity less than/equal to 20 years for corporate Fixed Income Securities;

- Fixed Income Securities denomination currencies EUR, GBP, USD, AUD, CAD, CHF, DKK, JPY, NOK, NZD, SEK in addition to the eligible ratings.
- Government and Sovereign Fixed Income Securities denominated in HKD, SGD and KRW;
- Government and Sovereign Fixed Income Securities issued by Italy, Spain and Japan;
- Only OECD countries plus Singapore and Hong Kong are accepted as an issuer country where eligible in the Clearstream Banking system for Government, Sovereign, Agency and Corporate Fixed Income Securities;
- Covered Bonds (for example, Corporate Fixed Income Securities backed by cash flow from mortgages or public sector loans) are accepted if the Issuer is established in an EAA member country or either Switzerland or the UK;
- Evaluated prices are accepted for collateral valuation for short-term Securities only.

The "ratings" referred to herein are those issued by Standard & Poor's, Moody's Investors Service and Fitch Ratings Ltd. Where the ratings from these agencies vary, the lowest available will be used.

7.8 Interest calculations and reporting

The calculation of interest for a given month is reported to Clients in the Monthly Interest Scale report, Notification of Interest (MT935), which is available in the morning of the tenth calendar day of the following month (or, if that is not a Business Day, on the next available Business Day after that).

After the interest calculation has been made and reported, subsequent Back valuations will not be included in the interest scales. Adjustments can only be made by separate book-entry over the account.

Back valuation of funds movements on transactions between CFCL and CBL counterparties that fail to settle on the requested settlement date is not possible. In each settlement processing, the value date for funds movements on internal Transactions is determined by the settlement date of the processing. For this reason, Clients who want to make compensation adjustments for late settlement should arrange to pay compensation by a separate transfer of funds, rather than request CFCL to execute back valuation adjustments.

Debit interest is charged on value dated debit balances and is reported as an MT103, or MT200/202 Transaction.

The daily interest rate shall be composed of the following:

- The available interbank money market overnight offer rate for the relevant currency; and
- A risk weighted debit margin applied in accordance with CFCL's risk assessment on the CFCL credit user and the currency group availability.

Client debit margins

Currencies	Rating	Risk weighted debit margin
USD, CHF, GBP, AUD, CAD, DKK, NOK, SEK, JPY; EUR and NZD	AA or A	1.50%
	B	2.00%
	C or D	2.25%
	E, F or G	2.50%
	H, I, J or K	3.75%
Other currencies		4.50%
HKD		4.50%
ZAR		7.50%
PLN		5.50%
CZK		6.50%
HUF		6.00%
Other currencies		4.50%

7.9 Income main transfer account

The income main transfer account (Transfer 1) is a service that allows the automated transfer of income payments and fees from one CFCL account to another CFCL account defined as the Client's income main transfer account.

Clients can subscribe to the Transfer 1 service by sending a Swift MT599 (for the attention of Account Administration). The income main transfer account service is a way for Clients to streamline their internal reconciliation processes by centralising their custody proceeds (interest, dividend, reimbursement proceeds), invoices, and debit interest in the same account regardless of the number of settlement accounts in CFCL.

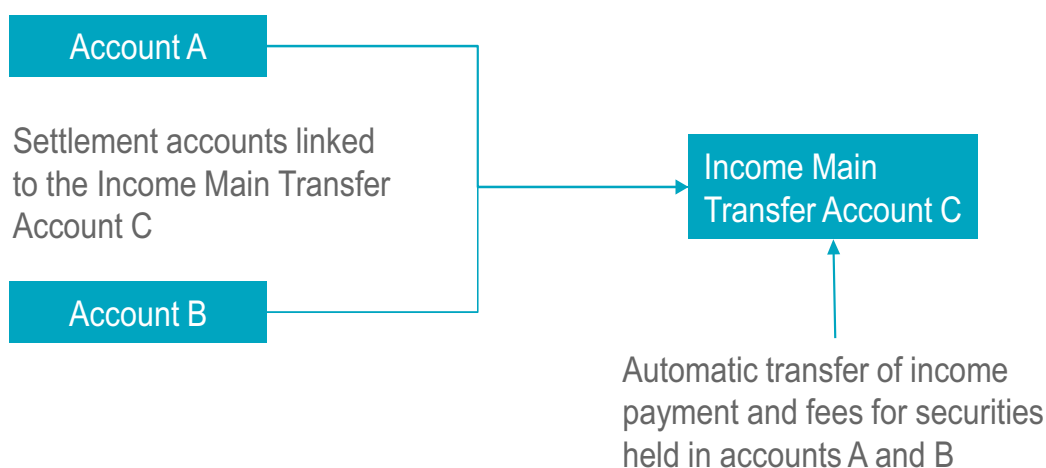

Figure 7.8 Income main transfer account

- Automatic income transfer is possible in all settlement currencies.
- Income cash proceeds are credited directly to the income main transfer account while the following fees are charged to that same account:
 - billing fees;
 - out of pocket expenses;
 - monthly interest payments.

This page has intentionally been left blank.

8. Asset Servicing

CFCL provides Clients with a full range of asset servicing for income and corporate action (non-income) events that consist of:

- Income services;
- Corporate Action services;
- Event notification and entitlement forecast;
- Payment management of asset servicing proceeds;
- Transaction management;
- Tax services;
- General Meetings services.

CFCL Clients can access asset servicing processing and reporting via:

- CFS Portal;
- File Transfer;
- Swift or other communication media when Swift cannot be used.

Note: In accordance with the terms and conditions of an issue, custody operations may be subject to prior certification of beneficial ownership.

Additionally, some instruction options or certifications may be available for specific account asset types only (own assets, Client segregated or Client omnibus accounts). The Client must ensure that the current account asset type reflected in CFCL's systems is one that allows the type of instruction option or certification intended to be sent to CFCL with respect thereof. If CFCL receives instructions related to asset services which are incompatible with the account asset type defined for the instructing Client account, CFCL reserves the right to reject or revoke such instructions at any time.

Note: Short selling of income or corporate action proceeds is not authorised for settlement in CFCL. For further information, please refer to "[Short selling](#)".

8.1 Income services

Income services relate mainly to the calculation of Client entitlement and distribution of proceeds.

Income events with options are considered by CFCL as corporate action events.

Income events

Income events include dividends capital gains and capital distributions.

Daily dividends

For Investment Funds that calculate dividends on a daily basis, CFCL receives the applicable dividend payments after the completion of each dividend accrual period. Such Investment Funds will regularly have 12 accrual periods per year. Clients will only receive any accrued dividends owed to them pursuant to the execution of a redemption/sell Investment Fund Order after the relevant dividend accrual period has ended. This also applies to Investment Funds that are considered as being the "dividend close-out" type.

Income key dates

Figure 8.1 shows the timeline of the key dates for an income payment.

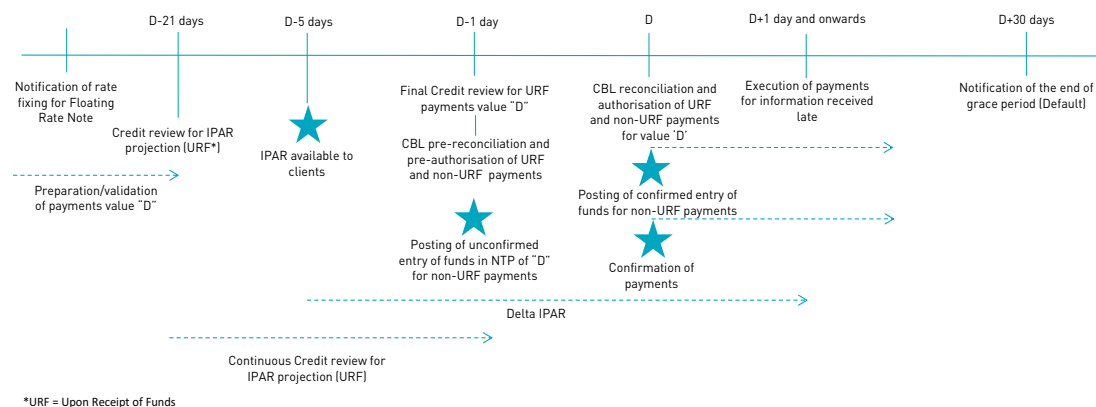

Figure 8.1 Typical timeline of event set-up and processing

Record date

Record Date is the date on which CFCL establishes which holders are recorded in the system as eligible to receive the income event.

For Euro-instruments, the Record Date is usually the close of business, one Business Day before the payment date of the entitlement. For domestic Securities, the Record Date varies for different security types according to domestic market practice, as detailed in the Market Guide.

As a general rule, entitlement to income distribution is calculated on the Record Date of the relevant payment. For account holdings that qualify for income distribution, this is determined after the end of day processing. However, Clients should note that information may be received from depositories and TAs after the deadline for inclusion in the end of day processing, resulting in later adjustment to entitlement positions.

Application of adjustment on Record Date is processed in the same way for both domestic and international markets to facilitate the compensation process.

8.2 Corporate action services

A corporate action is any event that impacts the rights of an investment fund's shareholders excluding income events like Dividend payments.

It may be initiated by the Issuer, a third party or an action of holders. For some corporate action events, holders must respond by selecting from a list of possible actions.

CFCL informs Clients about all upcoming corporate actions applying to securities held on their account, where information about the event has been provided by an authorised and authenticated party and where the initiator of the event is recognised as authorised to do so. This excludes non-official offers and/or offers handled outside the clearing system.

CFCL sends individual notifications, via the connectivity channels, for each holding in the security. To ensure highest quality, CFCL applies ISO 15022 standards (use of ISO Corporate Action Event Indicators, use of structured fields etc.) and indicates whether the message is a new message, a

cancellation, a replacement, a withdrawal or a reminder. For funds with FPG = Vestima Prime, different communication media's can be used when the usage of Swift is not adequate.

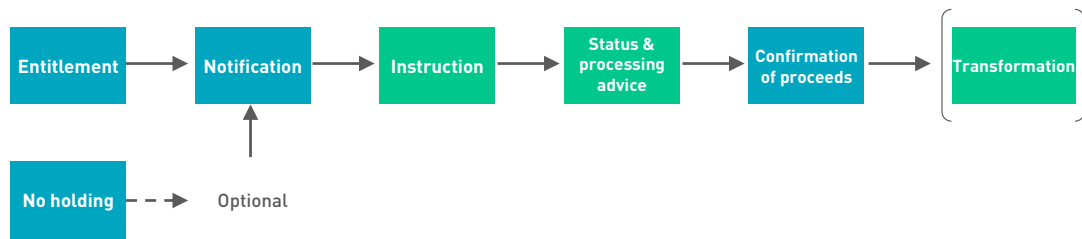

Figure 8.2 Corporate action event life cycle

Clients are requested to verify in advance their account setup eligibility to receive underlying proceeds for a corporate action event. Clients of CFCL are reminded that only investment funds instruments are eligible for settlement on their account and other instruments types (for example, equities, bonds) resulting from a corporate action event must be received outside of CFCL. Their account profile and the actual beneficial owner need to comply with restrictions applying to these proceeds. If account setup restrictions do not permit the crediting of underlying proceeds (for example, due to tax or market restrictions), delivery details outside CFCL must systematically be included on the respective instruction.

Corporate action events

Corporate actions can be divided into two broad categories of events:

Predictable events

In limited instances, there are predictable events that occur. Events foreseen in the security's documentation (for example, the terms and conditions), including wording around the event timing and deadlines. Security documentation collected by CFCL is made available to Clients through CFS Portal.

Unpredictable events

Events not foreseen in the security's documentation (for example, terms and conditions). They are announced and described in additional documents by the issuing company's management.

Examples of unpredictable events: purchase offer, stock split.

Both predictable and unpredictable events can be subdivided into three main categories based on whether the holder of the securities has to take action on the event or not.

Mandatory events

Participation and consequences are compulsory and apply to the whole outstanding amount held within CFCL. No instruction from the security holder is required.

Examples of mandatory events: stock split, rights distribution, merger.

Mandatory events with choice

Participation and consequences are compulsory and apply to the whole outstanding amount held within CFCL; however a choice or option is available to the security holder. An instruction is only required if the security holder does not want the Default Option to be applied.

Example of a mandatory event with choice: merger with choice.

Voluntary events

Participation and consequences are at the holder's discretion. An instruction is required if the security holder wishes to participate. The Issuer will usually inform all holders of the event that is about to take

place; sometimes this notice is provided in the original offering documentation for the security. If no action is taken by the holder, then the default action as stated in the notification will be applied.

Examples of voluntary events: purchase offer, exchange offer, subscription offer.

Some complex corporate actions may involve mandatory events with subsequent voluntary events (two leg events), for example, mandatory rights distribution followed by a subsequent voluntary subscription offer.

CFCL supports all types of corporate actions events defined by the CASG standards.

Cash distributions

Cash distribution is a distribution where the proceeds consist of cash only (for example, cash dividend, interest payment)

Three key dates are used for mandatory cash distributions:

- the Ex-Date;
- the Record Date;
- the payment date.

Securities distributions

Securities distribution is a distribution where the proceeds consist of securities only (for example stock dividend, bonus issue).

The key dates and the order of dates used for securities distributions are the same as for cash distributions.

Distributions with options

As a general rule, the distribution with options is handled via two events:

- a distribution of interim securities (refer to securities distribution above) followed by
- mandatory reorganisation with options (refer to mandatory reorganisations below) (for example optional dividend).

The key dates and the order of dates are the same as for cash distributions for the first event and the same as mandatory reorganisation with options for the second event.

Mandatory reorganisations

Mandatory reorganisation is a reorganisation that mandatorily affects the underlying security (for example stock split).

Three dates are used for mandatory reorganisation:

- the last trading date;
- the Record Date;
- the payment date.

Mandatory reorganisations with options

Mandatory reorganisation with options is a mandatory reorganisation with a choice of proceeds (for example, merger with election).

The following dates are used for reorganisations with options:

- start of election period;
- end of election period;
- guaranteed participation date;
- buyer protection deadline;
- response deadline;

- market deadline;
- payment date.

Voluntary reorganisations

Voluntary reorganisation is a reorganisation in which participation is optional for the holder of the underlying security (for example, tender offer).

The key dates and the order of dates used for voluntary reorganisations are the same as for mandatory reorganisation with options.

Corporate action instructions

Clients may instruct on voluntary and mandatory with choice events using the following media:

- Via CFS Portal;
- File Transfer;
- Swift MT565 message by using the BIC address: DBFCLULL;
- For funds with FPG= Vestima Prime, other connectivity media's can be accepted when the usage of Swift is not adequate.

Instructions received from Clients are validated by CFCL and forwarded to the depository or the agent either one by one or bulked on deadline date. If a corporate action instruction does not include an execution date, the instruction will be considered as if received for processing on the next possible execution date.

The service will differentiate between following instruction statuses:

- Correctly formatted instructions will benefit from a more competitive CFCL deadline.
- Free format messages and unsolicited instructions will have a standard deadline and will be subject to an additional fee.
- Incorrectly formatted instructions will have a standard deadline.

Note: Incorrectly formatted instructions increase the risk of rejection.

In order to encourage the correct formatting of Corporate Action instructions the pricing model will apply an additional fee to free format messages, unsolicited instructions and manual repairs.

- Unsolicited instructions (Swift MT565, CFS Portal or File Transfer) where the corporate action reference ID is missing and for which the Client has received this corporate action reference ID previously in the related MT564 Corporate Action Notification before sending the instruction.
- Any Client instruction received via Swift MT565, CFS Portal or File Transfer where the required information has been incorrectly populated through dedicated structured fields."
 - instructions where the Beneficiary details are required and are not included in the dedicated structured fields from BENODET sequence will be manually repaired and subject to an additional fee.
 - instructions for Dutch Auction events, where the Bid Price for the competitive option is provided, will be manually repaired on a best effort basis and subject to an additional fee in the following instances: the bid price is not included in the structured field :90a::OFFR// or is not correctly formatted.

Incorrectly formatted instructions provided via Swift MT565 or CFS Portal that are automatically rejected will immediately trigger a Swift MT567 Corporate Action Status and Processing Advice indicating the reason for rejection.

In order to further improve STP processing and to provide CFCL deadlines closer to market deadlines, CFCL will:

- Ignore certain narrative types in the MT565 Corporate Action Instruction, as indicated:

- When present in the Instruction block (CAINST):
- COMP: Information to be complied with;

When present in the Additional Information block (ADDINFO):

- PACO: Party narrative.

Ignore any narrative type for specific corporate events unless the event specifically requires the use of a narrative. Clients will be informed that the rule is applicable for a given event through the relevant MT564 Corporate Action Notification. A fixed standard text will be added in the notification (Additional Text (ADTX) in the Corporate Action Options block (CAOPTN)). This text will specify that any narrative received in the Client instruction on the related option will be disregarded.

For all events (if applicable) the standard deadline for free format messages, unsolicited instructions and incorrectly formatted instructions will be provided in the Corporate Action Notification.

Note: CFCL will not be held liable for not taking any action on any instruction that is not sent via the proper channels (Swift, CFS Portal or File Transfer via CSV file upload) unless unavailable.

Instruction format

To ensure fast processing and to benefit from the full life cycle of information, Clients should send corporate action instructions using an available connectivity method:

- Standard rules for the completion of the Swift MT565, as described in the Swift User Guide, must be followed. For funds with FPG= Vestima Prime, other connectivity media can be used.
- Any additional information required as described in the corporate action notification must be included.

Note: For corporate action instructions for French registered securities, Clients are requested to instruct CFCL using one MT565 for each beneficial owner, mentioning the beneficial owner details in the field :70E::REGI. For further details, please refer to [Market Link Guide - France](#).

For instructions sent as free-format messages, automatic validation and processing is not applicable. Free-format instructions can be accepted, respecting the following data as mandatory to ensure validity:

- Exact event type;
- Corporate action reference ID and/or event name;
- Client account number;
- Nominal quantity;
- The financial instrument identification number (ISIN or Common Code);
- The selected option (note that "No Action - NOAC" instructions are considered as an option);
- Any additional information required as described in the corporate action notification.

For risk management reasons, corporate action instructions by fax or email are not accepted, except for funds with FPG = Vestima Prime. Clients operating in contingency mode may be allowed to instruct via fax or email provided they duly execute a letter of indemnity in favour of CFCL.

Clients must only include one instruction per message. One instruction consists of: one financial instrument identification number (ISIN or Common Code), one account number, one nominal, one option (No Action - NOAC instructions being considered as an option). If a Client includes more than one instruction per message, or if the additional text field on formatted messages includes an instruction or contradicts with the instruction given in the structured fields, CFCL cannot be held responsible for any loss or damage caused. CFCL reserves the right to reject instructions not formatted as per recommendations.

CSV file upload

Clients can upload a CSV file with up to 1,000 instructions via CFS Portal.

To cater for higher volumes, Clients can upload a CSV file with up to 1,000 instructions via File Transfer via Internet.

For risk management reasons, to upload a CSV file with more than 1,000 instructions, Clients must communicate to Client Services their intention to use this functionality at least 24 hours before the relevant CFCL deadline (this is the earliest deadline if there are events with multiple deadlines), providing following data:

- Corporate action reference ID;
- Number of instructions to be uploaded.

Upload via File Transfer via Internet with more than 1,000 instructions must be completed at least three hours before the relevant CFCL deadline (this is the earliest deadline if there are events with multiple deadlines).

Failure to comply with above requirements will result in CFCL handling the instructions on a "best efforts" basis and execution cannot be guaranteed.

This connectivity media does not apply to funds with FPG= VestimaPRIME.

Instruction collection

Solicited events fall under a predefined exercise period punctuated by a deadline, as reported on the corporate action notification. Clients should always send instructions before the CFCL deadline.

Instructions are processed according to deadline priorities.

Unsolicited events fall under an open exercise period and can be instructed anytime. As a standard rule, valid Client instructions are processed on a continuous basis throughout the day.

Holdings will be blocked, unblocked or debited for delivery, if appropriate, based on the instruction and the corporate action type and terms when a valid instruction is received from the Client. For a corporate action instruction received before an exercise period, CFCL will not perform any preliminary blocking of securities.

Important Note: CFCL will only be responsible for processing a corporate actions instruction received via the usual channels and in relation to a position in its books. CFCL cannot be held liable for any damage incurred in relation to a corporate actions instruction that would be directly sent by a Client to the agent in relation to a position held with CFCL. This practice is not supported by CFCL.

Late instructions

Instructions received after the CFCL deadline are handled on a best-efforts basis and are transmitted to the depositories/agents, however, execution cannot be guaranteed. If the instruction received after the CFCL deadline cannot be executed, CFCL will apply the default action stated in the notification (default indicator).

When an instruction comes in after the deadline, Clients receive an acknowledgement (MT567), advising the Client that the instruction is after deadline and will be processed on a best-efforts basis. After feedback from the depositories/agents a revised processing advice is sent to Clients.

Formatted Client instructions received during suspension periods or before exercise periods will be automatically rejected. However, if the suspension period end date or the exercise period start date is within five Business Days of receipt of the instruction, the instruction will be held in suspense until such dates are reached.

CFCL cannot be held liable for the non-execution of late, incorrect or incomplete instructions.

No action instruction

"No action" instructions are considered and recorded by CFCL with the same priority equal to all other instructions. As a result, positions instructed for 'no action' will not be eligible to participate in the respective event unless the instruction is cancelled and replaced.

Cancellation of previous instructions by Clients

If instructions have already been processed and forwarded to the local market, the transfer agent or the depository, CFCL will forward the cancellation request accordingly but cannot guarantee execution of the cancellation request.

To replace an instruction already sent, Clients must send a cancellation message before the new instruction.

Clients are requested to cancel formatted instructions with a formatted cancellation only (Swift MT565 and CFS Portal).

CFCL cannot be held responsible for any loss or damage caused by a Client's failure to comply with the cancellation and replacement procedure.

Missing instructions

The Urgent Uninstructed Balances report, available through File Transfer, gives an overview of uninstructed Balances for corporate actions and assists Clients in monitoring risk relating to voluntary corporate actions. If no instruction is sent, CFCL will apply the default action stated in the notification (default indicator).

Completion of paper forms on behalf of Clients

CFCL includes, as part of its standard custody service, the completion of paper forms to participate in a corporate action provided this is permitted under the terms and conditions of the issue and/or by the Issuer or its Issuing Agent. There are however events where it is a requirement that the form be completed and signed by the actual legal or beneficial holder in which case we provide our Clients with the necessary forms or information on how to obtain the forms in order to participate in the event.

Status and processing advice

Clients instructing via Swift MT565 and CFS Portal will receive a status and processing advice message for each corporate action instruction sent to CFCL.

Clients using CFS Portal can check the status of their corporate action instructions directly in CFS Portal and schedule the receipt of an MT567 via Swift. For funds with FPG= Vestima Prime, Clients receive confirmation of the processing of their election via secured email.

In order to receive acknowledgements via Swift, a valid Swift address is required and the check boxes for "Acknowledgement of MT565 messages" and "Include all media channels" must be checked in the Scheduled Reports details.

If the corporate action instruction was sent using a free-format message, Clients will not receive a status and processing advice and are responsible for monitoring the instruction execution.

Rejection of instructions

If the securities provision is not sufficient, instructions will not be executed, but held in suspense either for a period of five consecutive Business Days starting on the date of receipt of the instruction or until the relevant CFCL deadline, whichever occurs first.

CFCL will inform the Account Holder of the non-execution and rejection of corporate action instructions in the following cases:

1. The instruction is incomplete or invalid (as per, without limitation, instruction format definition).
The required certification or document is not provided together with the related instruction.
2. The specified place of safekeeping in the related instruction does not correspond to the depository defined in the event referred by the Corporate Action Reference ID (received in the related MT564 Corporate Action Notification).
3. The corporate action reference ID is missing and the CAEV, ISIN (or common code) and place of safekeeping (:94F::SAFE) provided in the related instruction do not match with an event.

4. Any additional requirements are not satisfied (e.g. if the proceeds security is not CFCL eligible; if the appropriate delivery instruction outside of the CFCL system is not provided with the instruction).

CFCL cannot be held responsible for any loss or damage caused by a delay in the execution of an instruction or cancellation of an instruction that did not fulfil one or more of the above conditions.

Handling of corporate actions requiring payment of exercise price

For corporate action events requiring payment of exercise price (for example priority issues, exercise of rights), Clients who have given their instruction to exercise should ensure their account is sufficiently provisioned (available cash or credit line in the relevant currency, where applicable) as per terms of the corporate action event.

As the securities still belong to CFCL, those will be sold on the market on a best effort basis and the Client agrees and undertakes to indemnify CFCL for the cash difference resulting from the sale. Such cash difference, if any, will be booked to the Client's account through CFCL via cash instruction. No credit of securities proceeds will follow.

Corporate action announcement	Corporate action election	Corporate action payment	
<p>MT564</p> <p>Notification for events subject to debit of exercise price has been announced to remind funding obligation on PD.</p>	<p>MT565</p> <p>Status of the instruction is reported via MT567.</p>	<p>MT566 (cash debit)</p> <ul style="list-style-type: none"> - On PD, account is subject to debit of exercise price. - Successful debit is confirmed via MT566. - Unsuccessful debit is reported via MT567 PENDING/MONEY → Grace period activation 	<p>MT566 (securities credit)</p> <ul style="list-style-type: none"> - On the securities distribution date, being PD or PD+x, the credit of proceeds is conditional to a debit of exercise price. - Successful credit is confirmed via MT566. - Unsuccessful debit of cash after the grace period is reported via MT567 REJT//NARR → Sale on the market procedure activation.

Figure 8.3 Corporate action event with exercise price - main processing flows for funds with FPG = Vestima

Sale and purchase of rights

CFCL offers a service to sell or purchase subscription rights. Given the evolution of the markets and deadlines on an ongoing basis, the full details of this service are described in Sale and Purchase of Rights, available on the website. Instructions to sell or purchase rights are executed in relation to the securities held in Custody with CFCL, in its capacity as securities settlement system, in accordance with the rules applicable in the domestic market covering a given event.

Fractions handling

CFCL will apply the agent's default action, which can be either a credit of the fractional units or the cash equivalent.

8.3 Event notifications and entitlement forecast

Event information

CFCL receives and compares corporate action information from different sources such as the terms and conditions of the issue, CFCL's depositories in the domestic markets, transfer agents, financial publications as well as independent information vendors. Corporate action¹ notifications are prepared based on this information and transmitted to Clients as soon as possible, generally within 24 hours after market announcement date.

CFCL's depositories and Transfer agents are the prime source of confirmed information for corporate actions. CFCL releases notifications when confirmed information is available. The information received from information vendors is considered as "unconfirmed" and may be used for domestic corporate action event set up and pre-notifications to Clients. CFCL will, at its own discretion, decide whether and when unconfirmed information is to be forwarded to Clients and CFCL flags such information as "unconfirmed" if provided.

Terms and conditions

CFCL summarises details of events via corporate action notifications. This summary will not constitute a legally binding description of the choices offered to Clients and cannot be relied upon as such. Clients are considered to fully understand the terms of the corporate action and to instruct CFCL accordingly. Clients may wish to seek independent legal and tax advice on the terms of the corporate action and its impact on their specific situation before instructing CFCL.

CFCL provides Clients with relevant publications by offering material or restrictions via the Corporate Action database, if and when they are available. Availability is advised through the corporate action event notification. Clients can place an email request to receive terms and conditions related to the event to CAdatabase.CS@clearstream.com (as per the terms of the related notification).

No part of the requested documents neither the information contained therein can be reproduced or transmitted in any form or by any means, electronic or mechanical, if neither the Client nor the addressee is entitled to participate in the relevant corporate action. Clients are aware that they shall bear sole responsibility for any and all harmful consequences, losses or damages, which may be suffered for any reason whatsoever by Clients, the addressee, third parties or CFCL by reproducing or transmitting the requested documents or the information contained therein.

Disclosure

In accordance with domestic market laws, investors may be required to disclose their relevant interest in securities. CFCL may be requested to comply with certain disclosure requirements, some of which are published, per market link on the website. Clients are informed of these disclosure requests by a specific notification. The notification will also advise Clients whether they are required to send an instruction or not.

Clients are advised to seek legal guidance on the existence and scope of any potential disclosure requirements applicable to such Clients and relating to their holdings. CFCL is not responsible for advising Clients on the validity and extent of disclosure requests.

Dissenter's rights

In accordance with domestic laws, investors may be allowed the right to receive a cash payment for the fair value of their securities, in the event of a corporate action to which the investors do not consent.

Clients are informed of this right by a specific indicator in the notification (DISS - Dissenter's rights).

1. In this section corporate action refers to both income and corporate action events.

For risk management reasons, Clients must communicate to Client Services their intention to make use of the dissenter's right feature immediately upon receipt of the relevant event notification and will be given all the pertinent information to perform their request to the company.

CFCL cannot be held responsible for any legal cost and fees incurred by dissenter investors pursuing this action.

Fees

In accordance with domestic laws, investors may be required to pay certain fees, if appropriate, based on the corporate action type and terms.

Clients are informed of these fees, if applicable, in the relevant notification.

Event reporting

The below mentioned reports will be sent to Clients to provide the account owner with the details of an event along with the possible elections or choices available:

Report purpose	Message Type	Description
New Message Notification	MT564 NEWM	New notification.
Replacement Notification	MT564 REPL	Supplementary information is provided.
Reminder Notification	MT564 RMDR	Reminder to client that CBL has not received their instruction.
Income Pre-Advice Report	MT564 REPE (IPAR)	Eligible balance notification, reporting an eligible balance that may or may not include an entitlement calculation or a revised entitlement calculation.
Claim and Reversal Advice	MT564 ADDB (CRA)	Notification of a market claim or reverse market claim subject to compensation by CBL that has been detected.
	MT564 CANC (CRA)	Notification of a cancellation of a reported market claim or reverse market claim.
	MT564 ADDB REVR (CRA)	Reversal advice of an income or non-income event. Reversal advice of a compensated market claim or reverse market claim.
Cancellation Notification	MT564 CANC	Cancellation advice of an event previously announced by CBL.
Withdrawal Notification	MT564 WITH	Withdrawal of the event or offer by the issuer (all previously sent event information is void).

The Corporate Action Notification messages (M564 NEWM) can be initially sent as a preliminary advice and subsequently replaced by another MT564 REPL with complete or confirmed information. An official corporate action reference (COAF) will be shown if allocated and reported by the Issuer CSDs.

CFCL endeavors to check the information with multiple sources with the objective to send notifications in a timely manner with status "confirmed" and "complete". In some cases, the terms of a corporate action or processing details may not be available until late in the life cycle.

"Incomplete" notifications may be sent in order to provide Clients with the available information.

In CFS Portal, a specific flag facilitates the identification of events where instructions are requested: "For Your Information" (FYI) notification will be sent for the mandatory events where no action from the Client is necessary. Voluntary events will be created as "Your Instruction Requested" (YIR). The events concerned are those requiring a decision or action from the holder of the securities.

Whenever the event is cancelled or withdrawn, it will be reported via the appropriate message (MT564 CANC/WITH).

CFCL informs Clients about upcoming mandatory and voluntary corporate actions applying to securities held on their account as soon as possible and only after being notified of an event. The entitled holding is fixed on Record Date or on actual date, according to the terms and conditions of the relevant corporate action.

Notifications for the relevant securities holdings are released on a continuous basis during the day. Reminder notifications will be sent to Clients automatically for any uninstructed position.

CFCL sends the Reminder Notification messages (MT564 RMDR) "Your Instruction Required - Reminder" where the eligible position is either not instructed at all or partially not instructed. This message includes two additional balances, which are:

- INBA: Instructed Balance;
- UNBA: Uninstructed Balance.

Whenever applicable to the corporate action, the fraction handling details will be reported in standard fields.

Clients without a holding in a particular security can access the corporate action information, either using a query in CFS Portal or by subscribing to the dedicated "Corporate Actions Notifications without Holdings Report" in File Transfer or CFS Portal.

The Claim and Reversal Advice (MT564 ADDB REVR) notifies Clients of an upcoming reversal on one of the following paid income events:

- CAPD: Capital Distribution;
- CAPG: Capital Gain Distribution;
- DVCA: Dividend (including with a currency option).

Entitlement forecast

The Income Pre-Advice Report (IPAR)

The Income Pre-Advice Report (IPAR) enables Clients to retrieve available information on future proceeds (cash and securities) and capital repayments for all securities held in their accounts, for each place of safekeeping. The report covers the Dividend payments, interest payments, corporate action event payments and Redemptions, both partial and final, that are expected in the five Business Days following the report on a rolling basis. Proceeds which have not been executed on the scheduled payment date will be reported on IPAR for the next 30 calendar days after the scheduled payment date. After this period Clients will be notified of any event of non-payment or default and further follow-up processing will be performed by the corporate actions team.

Reports can be retrieved selectively by currency, date, event type or Security Code. The IPAR is accessible through:

- Swift MT564 (Corporate Action Notification), the standard use of which can be replaced by, MT568 (Corporate Action Narrative) in exceptional cases;
- File Transfer (in XML, XLS and PDF format);
- CFS Portal.

In the IPAR, securities Balances are updated at 03:00, 08:00, 21:30 and 22:30. Entitled Balances (on Record Date) are fixed after the End of day processing that reflects the End of day Balances.

In addition to settled and eligible balances, IPAR shows a more complete set of balances, such as:

- AFFB: Affected Balance;

- UNAF: Unaffected Balance;
- PEND/ELIG: Pending Delivery Eligible Balance;
- PEND/NELG: Pending Delivery Not Eligible Balance;
- PEND: Pending Delivery Balance;
- PENR/ELIG: Pending Receipt Eligible Balance;
- PENR/NELG: Pending Receipt Not Eligible Balance;
- PENR: Pending Receipt Balance;
- INBA: Instructed Balance (applicable only for events requiring instruction);
- UNBA: Uninstructed Balance (applicable only for events requiring instruction).

The IPAR (MT564 REPE with ADDB//CAPA) gives the following details:

- Breakdown of the cash and/or securities payment that will be done for the account;
- Tax related information, including net calculated entitlement;
- Any debit movement of security;
- Settlement position and eligible quantity;
- Pending receivable cash amount/securities based on entitlement.

In addition, intraday IPARs will be generated if important details about a payment (such as the rate of interest or the Record Date) have been updated for the related value date. These additional intraday IPARs will only include the updates to existing proceeds and new proceeds created on Value date -1. They will not be created for updates to Balances arising from any intraday Settlement activities.

IPAR is available in two forms:

- The complete report, which covers all cash and securities proceeds that are expected to be payable to the account for each place of safekeeping during the succeeding five Business Days; and
- The delta report, which covers only those proceeds that are new and/or changed since the last report that was retrieved, thereby allowing easier identification of new items and reducing reporting costs.

For both types of IPAR, Clients have the choice of whether or not to include Pending Transactions. This feature is not available to income on Equities although the total quantities of Pending receivables or deliverables are shown on the report.

The IPAR is not a confirmation of receipt of proceeds, but rather a projection of cash and securities to be expected which is subject to CFCL's conditions for income and Redemption payments. Therefore, CFCL provides the IPAR for information purposes only. CFCL does not warrant the accuracy and completeness of the IPAR. CFCL shall not be liable for any action taken based on this report.

List of events

The following figure is a non-exhaustive list of the corporate action events that are currently handled.

Each description is a brief definition used internally, and as such may not reflect all characteristics of the event as it may be defined by the securities industry.

CAEV	Event	Description
ACCU	Accumulation	Funds related event in which the income (for example accumulation units) that accrues during an accounting period is retained within the fund instead of being paid away to investors. The retained income is nonetheless deemed to have been distributed to investors for tax purposes.

CAEV	Event	Description
BIDS	Repurchase Offer/Issuer Bid/ Reverse Rights	Offer to existing holders by the issuing company to repurchase its own securities. The objective of the offer is to reduce the number of outstanding securities.
BONU	Bonus Issue/Capitalisation Issue	Bonus, scrip or capitalisation issue. Security holders receive additional assets free of payment from the issuer, in proportion to their holding.
BPUT	Put Redemption	Early redemption of a security at the election of the holder subject to the terms and condition of the issue with no reduction in nominal value.
CAPD	Capital Distribution	The Corporate event pays shareholders an amount in cash issued from the Capital account. There is no reduction to the face value of a single share (or the share has no par value). The number of circulating shares remains unchanged.
CAPG	Capital Gains Distribution	Distribution of profits resulting from the sale of company assets, for example, Shareholders of Mutual Funds, Unit Trusts, or Sicavs are recipients of capital gains distributions which are often reinvested in additional shares of the fund.
CHAN	Change	Information regarding a change further described in the corporate action details.
CMET	Court Meeting	Announcement of a meeting at a Court.
CONS	Consent	Procedure that aims to obtain consent of holder to a proposal by the issuer or a third party without convening a meeting. For example, consent to change the terms of a bond.
CONV	Conversion	Conversion of securities (generally convertible bonds or preferred shares) into another form of securities (usually common shares) at a pre-stated price/ratio.
DLST	Trading Status: Delisted	Security is no longer able to comply with the listing requirements of a stock exchange and is removed from official board quotation.
DRIP	Dividend Reinvestment	Dividend payment where holders can keep cash or have the cash reinvested in the market by the issuer into additional shares in the issuing company. To be distinguished from DVOP as the company invests the dividend in the market rather than creating new share capital in exchange for the dividend.
DSCL	Disclosure	Requirement for holders or beneficial owners to disclose their name, location and holdings of any issue to the issuer.
DTCH	Dutch Auction	An action by a party wishing to acquire a security. Holders of the security are invited to make an offer to sell, within a specific price range. The acquiring party will buy from the holder with lowest offer.
DVCA	Cash Dividend	Distribution of cash to shareholders, in proportion to their equity holding. Ordinary dividends are recurring and regular. Shareholder must take cash and may be offered a choice of currency.

CAEV	Event	Description
DVOP	Dividend Option	Distribution of a dividend to shareholders with a choice of benefit to receive. Shareholders may choose to receive shares or cash. To be distinguished from DRIP as the company creates new share capital in exchange for the dividend rather than investing the dividend in the market.
EXOF	Exchange	Exchange of holdings for other securities and/or cash. The exchange can be either mandatory or voluntary involving the exchange of outstanding securities for different securities and/or cash. For example "exchange offer", "capital reorganisation" or "funds separation".
EXRI	Call on Intermediate Securities	Call or exercise on nil paid securities or intermediate securities resulting from an intermediate securities distribution (RHDI). This code is used for the second event, when an intermediate securities' issue (rights/coupons) is composed of two events, the first event being the distribution of intermediate securities.
INFO	Information	Information provided by the issuer having no accounting/ financial impact on the holder.
LIQU	Liquidation Dividend/Liquidation Payment	A distribution of cash, assets or both. Debt may be paid in order of priority based on preferred claims to assets specified by the security.
MEET	Annual General Meeting	Annual general meeting.
MRGR	Merger	Exchange of outstanding securities, initiated by the issuer which may include options, as the result of two or more companies combining assets, that is, an external, third party company. Cash payments may accompany share exchange.
OTHR	Other Event	Other event, use only when no other event type applies, for example, a new event type.
OMET	Ordinary General Meeting	Ordinary general meeting
PLAC	Place of Incorporation	Changes in the state of incorporation for US companies and changes in the place of incorporation for foreign companies. Where shares need to be registered following the incorporation change, the holder(s) may have to elect the registrar.
PRIO	Priority Issue	Form of open or public offer where, due to a limited amount of securities available, priority is given to existing shareholders.
REDM	Final Maturity	The redemption of an entire issue outstanding of securities, for example, bonds, preferred equity, funds, by the issuer or its agent, for example, asset manager, at final maturity.
RHDI	Intermediate Securities Distribution	The distribution of intermediate securities that gives the holder the right to take part in a future event.
SHPR	Shares Premium Dividend	This corporate event pays shareholders an amount in cash issued from the shares premium reserve. It is similar to a dividend but with different tax implications.

CAEV	Event	Description
SOFF	Spin-Off	A distribution of subsidiary stock to the shareholders of the parent company without a surrender of shares. Spin-off represents a form of divestiture usually resulting in an independent company or in an existing company. For example, demerger, distribution, unbundling.
SPLF	Stock Split/Change in Nominal Value/Subdivision	Increase in a corporation's number of outstanding equities without any change in the shareholder's equity or the aggregate market value at the time of the split. Equity price and nominal value are reduced accordingly.
SPLR	Reverse Stock Split/Change in Nominal Value	Decrease in a company's number of outstanding equities without any change in the shareholder's equity or the aggregate market value at the time of the split. Equity price and nominal value are increased accordingly.
TEND	Tender/Acquisition/Takeover/Purchase Offer	An offer made to holders by a third party, requesting them to sell (tender) or exchange their securities.
TREC	Tax Reclaim	Tax reclaim.
WRTH	Worthless	Booking out of valueless securities.
WTRC	Withholding Tax Relief Certification	Certification process for withholding tax reduction or exemption based on the tax status of the holder.
XMET	Extraordinary or Special General Meeting	Extraordinary or special general meeting.

8.4 Payment management of asset servicing proceeds

The asset servicing proceeds (cash or securities) are paid to Clients on their CFCL accounts.

If the proceeds are not CFCL eligible at all or if the proceeds cannot be paid to the Client account due to specific account restrictions, Clients will be asked to provide the delivery details to CFCL to execute the payment accordingly.

Payments are always made upon receipt of funds unless otherwise specifically confirmed.

All proceeds are paid in the original payment currency as determined by the Issuer, on condition that the currency is recognised as eligible.

In respect of ESMA regulation (EU) 2017/392 Article 86.3, where a corporate action will reduce the balance of a securities account, the securities and cash Settlement instructions for the relevant securities issue will not be processed until the corporate action has been fully processed by the (technical) issuer CSD (that is, other CSD), and the confirmations have been received. This may lead to a desynchronisation of the cash and securities bookings.

Redeemable securities are automatically presented for payment and the proceeds credited to Client accounts on payment date, after deduction of applicable withholding taxes, and under reserve of receipt of funds by CBL's Cash Correspondent.

Income and Redemption proceeds provide important funds provision for Settlement. Payments are released on the relevant payment date, once confirmed by our depository/agent and once reconciled. Payments can be booked to a Client's account at multiple times during each Business Day. This allows immediate release of payments when funds are received.

The credit to the Client's account may be delayed if the payment has not been received, reconciled or validated on time (for example, late information on the market, discrepancy).

Confirmation of income and Redemption payments is available via:

- Swift MT566 (Corporate Action Confirmation), the standard usage of which may be replaced in exceptional cases by MT568 (Corporate Action Narrative); or
- Confirmation of Income and Redemption Proceeds Report in CFS Portal; or
- File Transfer in XLS and PDF format.

Corporate action payments

CFCL credits all cash and security proceeds, if CFCL eligible, resulting from a corporate action on an upon receipt basis only.

Settlement and value dates mentioned in the notifications are those officially announced in the event's terms and conditions. Actual credit may, however, take place later due to practical reasons, for instance different time zones and reconciliation purposes. Actual credit may be delayed or take a different form for instance if any insufficiency and/or ineligibility of underlying fund proceeds at redemption date of the Fund Linked Note. CFCL will not be responsible for any damage incurred due to a delayed credit of proceeds if such a delay is beyond its responsibilities.

Proceeds booking on events may happen on a unique or on an ongoing (rolling) basis depending on whether the proceeds (cash or securities) will be released by the agent only once after the corporate action's deadline, or at multiple points in time during the corporate action.

Proceeds credited are confirmed to Clients via CFS Portal, Swift MT566 messages and File Transfer.

Clients receiving securities from a corporate action event will be deemed to indemnify CFCL for any taxes, penalties, interest thereon and other costs that CFCL may incur as a result.

New payments following a reversal of an income payment

Whenever a new payment is applicable following a reversal execution of income events, the details are announced via an MT564 Corporate Action Notification and via an MT564 Income Pre-Advice Report (IPAR). Clients that were previously entitled but are no longer entitled due to the record date or ex-date change will not be notified of the new payment.

The new payment execution is confirmed via an MT566 Corporate Action Confirmation. It will be linked to the MT564 IPAR of the new payment.

8.5 Transaction management

Transaction management refers to corporate actions¹ on flows (pending instructions). It includes market claims (reverse market claims), transformations and buyer protection.

The rules described in this section are standard procedures which may vary in some instances. Specific rules are detailed in the Market Link Guides.

Market claims and reverse market claims

Market claims and reverse market claims refer to the process of the reallocation of the proceeds of a distribution to the contractually entitled party. The market claim and reverse market claim life cycle includes detection and compensation of market claims or reverse market claims.

1. In this section corporate action refers to both income and corporate action events.

Detection rules

CFCL automatically processes detection of market claims and reverse market claims for internal and external transactions. No detection occurs on external instructions in markets where no market claim or reverse market claim process is in place.

All settlement instruction types, whether free of or against payment, are subject to market claims and reverse market claims detection.

Only matched instructions are detected.

Market claims are detected from the end of the Record Date (or once the instruction settles in the case of a reverse market claim) and subsequently in real time during a detection period of 20 business days after the Record Date.

The market claim or reverse market claim applies to all distribution events:

- CAPG: Capital Gains Distribution;
- DRIP: Dividend Reinvestment;
- DVCA: Cash Dividend;
- DVOP: Dividend Option.

Key dates

The use of the Settlement Date rule or the Trade Date rule is aligned with the T2S accounting model and is based on the quantity type of the financial instrument.

The Settlement Date accounting rule applies for securities in nominal.

The Trade Date accounting rule applies for securities in units. No compensation will be paid if the Settlement instruction of one of the parties does not include the Trade Date.

Settlement date accounting rule

A market claim is generated if a transaction in nominal shows a requested Settlement Date prior or equal to Record Date but is only settled after Record Date.

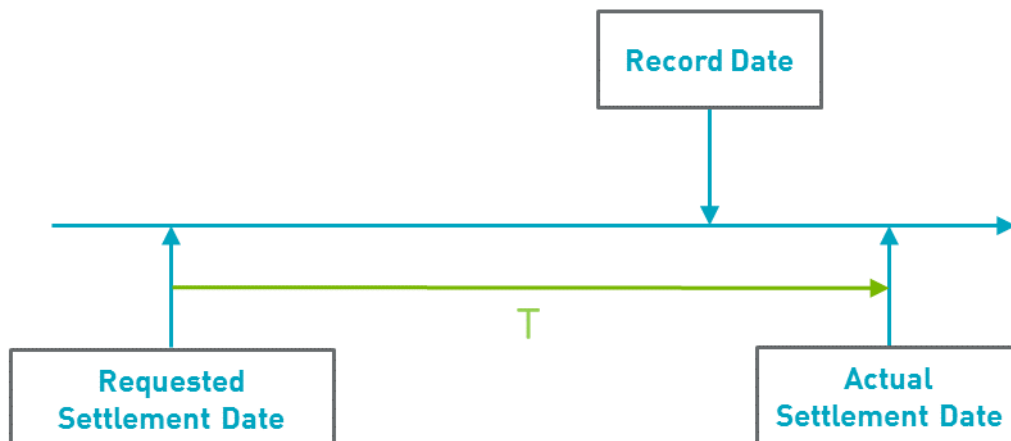

No reverse market claims can be generated for Settlement Date accounting rule as there is no Ex-Date.

Trade date accounting rule

A market claim is generated if a transaction in units shows a Trade Date prior to Ex-Date but is only settled after Record Date. The direction of market claim is from the seller to the buyer.

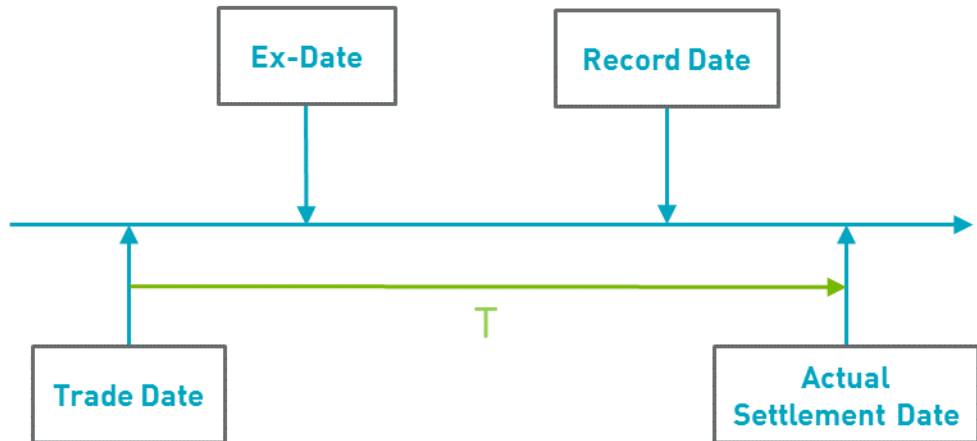

A reverse market claim is generated if a Trade Date is on or after Ex-Date but is already settled prior to or on Record Date. The direction of reverse market claim is from the buyer to the seller.

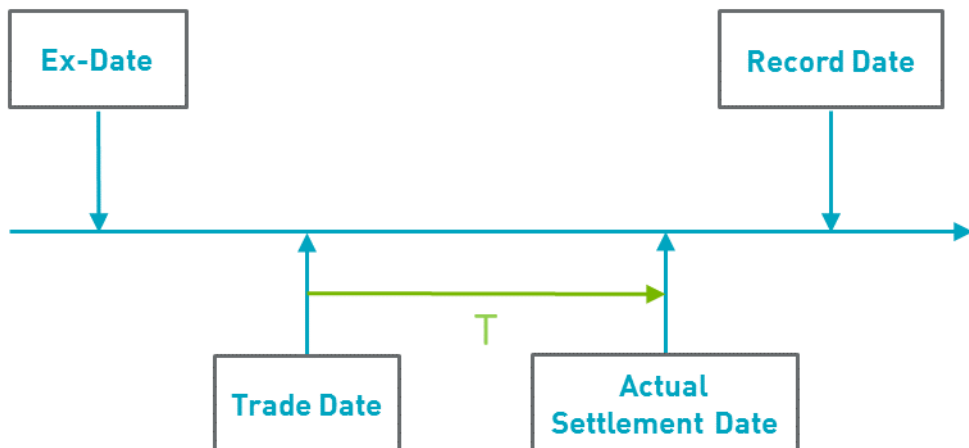

Opt-out, ex and cum indicators

Clients can specify in their Settlement instructions if they want their trades to be excluded from the generic market claims or reverse market claims detection of CFCL. This can be done via the opt-out indicator.

Clients can specify in their Settlement instructions if they want their trades to be treated as ex or cum irrespective of the Trade Date. This can be done via the ex or cum indicators.

Indicator	Description	ISO 15022 Swift field/qualifier
Opt-out	No automatic market claims detection	:22F::STCO//NOMC

Note: Clients can use the above-mentioned flag in Internal trades. If one of the counterparties includes one of these indicators in the instruction, and the market in which the traded security is deposited, supports its usage, this flag will prevent automatic processing of market claim compensation (opt-out) or change the way in which the trade is considered (Ex or cum).

These indicators are considered for instructions processed by T2S where the matching of these indicators is mandatory if included in one of the instructions.

For External instructions CFCL performs detection on the basis of STCO and TTCO values mentioned in the Client instruction.

Compensation processing

Compensations are generated for markets where a market claim and reverse market claim process is in place.

- For non-T2S markets, compensations are generated based on settlement of the underlying transaction and execution of the corporate action event.
- For T2S markets (excluding Austria, Germany and Slovak Republic), compensations are generated on record date end of day when the underlying instruction is at least matched (settled in case of reverse market claims), regardless the payment status of the related corporate action event.
- For Austria and Germany, in order to comply with local market practice, compensations are generated based on matched instructions but only upon execution of the corporate action event.
- For the Slovak Republic, according to local market practice, compensations are only generated based on settlement of the underlying transaction, regardless the payment status of the related corporate action event.

Market claims in T2S markets, with multiple proceeds where one proceed is non-T2S eligible, for a transaction with a counterparty outside of CBL or CFCL only the T2S eligible proceed will be compensated and accordingly reported with status "compensated".

Instructions with Euroclear counterparty, no matter on which market, will be subject to detection only. No compensation will be processed by CFCL.

For internal and cross-border trades, if market claims are applied on the market, CFCL automatically generates the market claim or reverse market claim compensation on behalf of Clients. These claims are generated via matching Settlement instructions on Client accounts. For cash compensations, this corresponds to an against payment instruction with zero quantity of securities.

The market claims or reverse market claims instructions have:

- The same Trade Date as the one of the underlying Settlement instructions;
- The intended Settlement Date, which is the payment date of the event; and
- The same status (that is, "On Hold" status) as the one of the underlying instructions at the time the compensation instruction is created. The Client can release this "On Hold" instruction by sending a MT530 or using the "Hold/Release" functionality in the CFS Portal.

For external transactions payments are compensated by means of separate cash bookings upon receipt of confirmation from local agents. The securities proceeds are credited on Client account via a settlement instruction upon receipt of confirmation from local agents.

For more information about local market rules, please refer to the Entitlement Compensation Rules information presented for each market link on the website.

Tax rate on the compensation and tax adjustment

For Internal trades, the tax rate of the compensation follows the market rule (gross or net of the maximum withholding tax rate).

Whenever a tax adjustment is needed, a separate settlement instruction will be generated. This corresponds to an Against Payment instruction with zero quantity of securities, which is visible via the CFS Portal.

The tax adjustment is reported in the MT566 Corporate Action Confirmation.

Market claims and reverse market claims reporting

The MT564 Claim and Reversal advice contains:

- Any market claim or reverse market claim subject to compensation by CFC;
- Tax adjustment amounts linked to a market claim or a reverse market claim as an additional cash movement;
- Any cancellation of a reported market claim or reverse market claim.

The MT564 Claim and Reversal Advice is not a confirmation of receipt of proceeds, but rather a projection of compensations to be expected. Therefore, CFCL provides this report for information purposes only. CFCL does not warrant the accuracy and completeness of the MT564 Claim and Reversal Advice. CFCL shall not be liable for any action taken based on this report.

The reversal of market claims and reverse market claims is notified via the MT564 Claim and Reversal Advice for the below income events (see "[Custody reports](#)"):

- ACCU: Accumulation;
- CAPD: Capital Distribution;
- CAPG: Capital Gain Distribution;
- DVCA: Dividend (including with a currency option);
- LIQU: Partial Liquidation;
- SHPR: Shares Premium Dividend.

An account-by-account overview of all potential market claims related to a Client's trades in securities is provided by the Custody Market Claims Report (see "[Custody reports](#)").

Market claims and reverse market claims in securities are included in the MT53x reporting and can also be included in the settlement reporting (MT54x). Clients currently have the option to include or exclude the reporting of compensation instructions in securities by selecting or deselecting "Custody Proceeds" from their MT54x reporting subscription. "Custody proceeds" also include securities proceeds resulting from corporate action events.

Market claims and reverse market claims in cash are included in the cash reporting (MT9xx).

Compensated market claims are also reported to Clients via MT566 with indicator:22F::ADDB/CLAI. The tax adjustment is reported in the MT566 Corporate Action Confirmation.

Market claims and reverse market claims are also visible in CFS Portal.

Transformations

Transformation is a process by which pending transactions, on or after entitlement date, are cancelled and replaced by the new transactions in accordance with the terms of the reorganisation.

The transformation life cycle includes detection of transformation, cancellation of underlying instruction and re-instruction, whenever applicable.

Detection rules

For mandatory reorganisation events, CFCL detects all pending matched trades. The detection of transformations is based on entitlement date:

- Record Date or effective date where applicable, for transformations related to mandatory reorganisations;

Transformations are detected as of end of day on Record Date if the settlement instruction has been identified as eligible.

The internal settlement instructions with an ISIN maturing due to a reorganisation corporate action and meeting the below conditions will be accepted over 20 business days after the maturity date:

- The trade date is before the maturity date; and

- The Intended Settlement Date (ISD) is before the maturity date + 20 business days.

Those instructions will be attempted for matching and once matched, will be eligible for transformation by Clearstream.

The events eligible for the CFCL transformation detection process on trades are listed below:

DVOP	Dividend Option with Rights (with debit of basis security)
EXOF MAND/CHOS	Exchange Offer
EXRI	Bonus Rights/Subscription Offer
EXTM	Extension Option
EXWA MAND/CHOS	Warrant Exercise
LIQU	Liquidation (with debit of basis security)
MCAL	Early Redemption
MRGR MAND/CHOS	Merger
PARI	Pari-Passu
PCAL	Partial Redemption by Face Value Reduction
REDM	Redemption in Shares at the Issuer's Option/Final Redemption
SOFF	Demerger/Spin-off
SPLF	Stock Split
SPLR	Reverse Stock Split
TEND	Tender Offer / Purchase Offer

Cancellation of underlying instruction and re-instruction

CBL cancels all pending matched trades whether or not the basis security code changes and whether or not transformations are applicable on the market.

For markets where transformation is applicable, CBL re-instructs transformations for any pending matched internal, external or cross-border trade.

CBL does not re-instruct transformations for:

- Euroclear instructions;
- Delivery free of payment without matching;
- Cross-border trades on all T2S markets when the event's cash or security proceed is non T2S-eligible.

Specific rules per market, if any, are outlined in the Market Guides on the website.

When CBL does not re-instruct the transformation, Clients must inject new instructions using the correct ratio.

For internal and cross-border trades, if transformations are applied on the market, CBL automatically generates re-instructions for via matching settlement instructions on Client accounts. For a cash re-instruction this corresponds to an against payment instruction with zero quantity of securities.

The securities quantity and cash amount in the re-instruction is calculated as in the terms of the reorganisation event.

Depending on market practice, and provided the initial instruction has been successfully cancelled, the re-instruction will be generated either:

- On Record Date/Market deadline at the end of day, regardless the status of the related corporate action event; or
- When the corporate action event has been executed.

Re-instructions are generated with the same status as the underlying instruction. MT54x Settlement instructions in securities with :22F::STCO//TRAN can be cancelled or modified by CFCL Clients by sending an MT530 or via the CFS Portal.

In case of multiple outturns, the re-instructions will settle independently (no link to each another).

The re-instructions are generated with:

- The same trade date as in the underlying instruction;
- The requested Settlement Date being the latest date between the payment date of the entitlement and the requested Settlement Date of the underlying transaction.

For external trades, CFCL will handle the transformation based upon the receipt of Settlement confirmation from the agents.

Opt-out indicator

Clients can specify in their settlement instructions if they want their trades to be excluded from the generic transformation detection of CFCL. This can be done via the opt-out indicator.

Indicator	Description	ISO 15022 Swift field/qualifier
Opt-out	No automatic transformation	:22F::STCO//NOMC

Note: Clients can use the flag in Internal trades. If one of the counterparties includes one of these indicators in the instruction, and the market in which the traded security is deposited, supports its usage, this flag will prevent automatic processing of transformation compensation (opt-out).

These indicators are considered for instructions processed by T2S where the matching of these indicators is mandatory if included in one of the instructions.

For Euroclear and External instructions, CBL performs detection on the basis of STCO value mentioned in the Client instruction.

Transformation reporting

As per the Corporate Actions Joint Working Group (CAJWG) standards, transformations are not subject to Corporate Action reporting.

Instructions that are cancelled as a result of transformations are reported in the MT548 Settlement Status and Processing Advice (See "[Clearing and Settlement reports](#)").

Re-instructions are included in Settlement reporting (MT54x) and Statements of Transactions (MT53x). Clients receive cash reporting (MT9xx) whenever the re-instruction is cash related.

The reporting includes a narrative with additional information relevant to transformations to ease the reconciliation.

The reports are also visible on the CFS Portal.

Buyer protection

Buyer protection is a process where a buyer who has yet to receive the underlying securities of an elective corporate action instructs the seller in order to receive the chosen proceeds. The objective of buyer protection is to ensure that the buyer in a pending transaction, who has acquired the right to elect in an (elective) reorganisation, will be able to express the preferred option, and receive the proceeds of their choice.

CFCL applies a manual buyer protection mechanism in line with corporate action standards. When buyer protection is supported in a market, the reporting of buyer protection key dates are described in the relevant Market Link Guide. To facilitate the buyer protection process, CFCL provides the following to Clients:

- Corporate Action notification MT564/568 messages (Notification, IPAR and CA Reference Data report) on the basis of Client pending positions including the buyer protection key dates. The buyer protection key dates, Election to counterparty, Market deadline and Guaranteed Participation Date are reported in ISO structured fields, which are also visible in the CFS Portal.
- The CASG compliant template for the buyer protection invocation.

8.6 Tax services

CFCL provides Clients with a number of tax services in various markets:

- Tax documentation service;
- Relief at source;
- Standard and quick refunds;
- Tax queries via CFS Portal;
- Client information form.

Tax documentation service

The tax documentation service covers the supply of information relating to:

- Certificates received from Clients in order to obtain exemption from, or a reduction of, withholding tax at source on taxable events (referred to hereafter as certificates); and
- Tax refund claim forms (referred to hereafter as refund forms) to reclaim all or part of the withholding tax initially paid on taxable events.

The main features of the tax documentation service are:

- The issuance of Acknowledgements of receipt for each certificate/refund form submitted and the respective confirmation of validity;
- The issuance of an "Expiry Report" in respect of certificates due to expire in one month's time.

Every Client that sends a certificate/refund form will receive, as appropriate, the documents described in the following sections.

Any certificate addressed to CFCL must be accompanied by a cover letter containing the account number and purpose of the certificate duly mentioned. Any refund form addressed to CFCL must be accompanied by a Letter of Request to CFCL. If the Client does not provide the Letter of Request, CFCL reserves the right to reject such refund forms.

To ensure efficient processing, Clients can only send certificates for accounts already open within CFCL. If a Client sends a certificate with multiple accounts, where some of them are not open in CFCL yet, CFCL reserves the right to reject such certificates.

Depending on the investment market requirements and on the specificity of documentation for tax relief, Clients may request the duplication of the certificates already submitted and validated by CFCL from one account to another.

Consequently, CFCL offers its Clients the possibility to duplicate (where applicable) original and valid tax certification via unsolicited instruction (Swift, CFS Portal or CFCL File Transfer) per market and having below mandatory text completed accordingly:

Request for duplication of tax certificates ATTN:

Tax Services
Market:

Source Account:

Destination Account:

Clearstream Fund Centre references of the impacted certificate(s):

We hereby confirm that above-mentioned original tax certificate(s) is/are still valid and should not be revoked.

We irrevocably authorise Clearstream Fund Centre to apply tax relief based on the information contained in the original tax certification duplicated for the destination account.

We hereby appoint Clearstream Fund Centre and Clearstream Fund Center's depository for the Securities as our attorneys-in-fact with authority to collect and forward the tax certification or a copy of the tax certification, any attachments and any information relating to it to the tax authorities if these prove relevant to any administrative or legal proceedings or official inquiries undertaken or threatened.

We accept full responsibility and indemnify Clearstream Fund Centre in the case of any claims or additional taxes, interest thereon or penalties levied by tax authorities in connection with any payments made in reliance upon this duplication of certification including any additional information provided in connection to it.

We certify, under penalty of perjury, that the information contained in the tax certification is true, correct and complete.

The duplication request should refer to the initial received and still valid original tax documentation (duplication of duplicated certificates is not acceptable). The duplication will generate a new tax certification registration with a unique reference, will be charged according to the usual tax certification processing fee and once registered, will be available via CFS Portal.

Acknowledgements of documentation

Depending on the communication means the Client is subscribed to, an acknowledgement is either mailed or communicated via Swift message for each certificate/refund form submitted to CFCL. For certificates, per depository/or tax agent, one acknowledgement is issued per account whereas for standard reclaims, one acknowledgement is issued per requested amount.

A unique identification number is assigned to each certificate/refund form submitted to CFCL. This number, which is included in the acknowledgment, needs to be referenced in all further submissions and queries related to the certificate/refund form in question.

Acknowledgements issued in respect of certificates/refund forms considered valid (that is, complete as to form and content) by CFCL include a Withholding Tax Certification Confirmation, summarising the details of the certificates/refund forms allowing our Clients to reconcile. Those acknowledgements are by default sent by Swift or CFS Portal message (referred hereafter as digital means of communication) but can be sent via regular mail upon request from our Clients. Any certificates/refund forms that are considered invalid are returned to Clients by registered mail for amendment, with the reason duly noted on the accompanying acknowledgement.

Subject to the Client having established that the documentation has been sent to CFCL, as per above, CFCL shall not at any time be held liable for any loss or damage caused by the non-processing of the certificates/refund forms, unless the Client has informed CFCL in writing of the missing acknowledgement prior to the Client instruction deadline, and no later than one month following the date of sending by the Client of its documentation, and CFCL is not able to demonstrate that such acknowledgement was sent to the Client, or in the case of CFCL's gross negligence or wilful misconduct in relation thereto.

Expiry Report

About one month before the expiry date of any standing certificate, a reminder (Expiry Report) is sent by post or communicated by digital means of communication to the Client with a summary of the details of that certificate.

Tax certificate query

Clients can query inventory information about tax certificates in CFS Portal. The tax certificate query provides a comprehensive record of tax certificates received as well as the certificate validity dates. Clients have the possibility to define their queries by account, market, depository, beneficial owner and/or event type.

For further information regarding tax certificate and tax refund queries see [Chapter 10. Reports and information services](#).

Relief at source and quick refund

CFCL offers relief at source and quick refund to Clients for a large number of markets, whenever such service is available via its depository/or tax agent, as specified in our Taxation Guides

Tax notifications

For forthcoming income and corporate action events in the markets concerned for which CFCL offers relief at source or quick refund, CFCL provides its Clients with pre-advice based on their entitled positions on the record date in the form of tax notifications via Swift, with details concerning the relief at source or quick refund process and references to Market Taxation Guide, Announcements and Tax Matrix, if applicable containing market-specific tax criteria. As a result, Clients can report their entitled positions in good time and submit the necessary documents to CFCL in order to benefit from relief or quick refund.

Tax notifications are only sent for the income and corporate action events for which CFCL offers a tax service to its Clients. Clients will consequently not receive any tax notifications for taxable income and corporate action events for which no relief at source or quick refund is offered by its depository or the tax agent.

Tax instructions

Any application for relief at source or quick refund on income or corporate action events shall be submitted to CFCL by the relevant account holder. The account holder is solely responsible for the content, continuing accuracy and completeness of any application and certification submitted with respect to securities held on its account(s) with CFCL (including any certifications from the underlying final beneficial owner).

CFCL does not provide any tax advice and by submitting any request the Client confirms that (i) it has made all relevant assessments, (ii) it has sought relevant professional advice and (iii) it does not rely on CFCL for the purposes of determining the tax rate applicable to the underlying beneficial owner of the taxable event.

Before submitting an instruction, Clients must ensure that when applicable, valid documentation and/or certification is in place.

Clients may instruct using the following media:

- CFS Portal;
- File Transfer;
- BO Upload;
- Swift MT565, MT568, MT599 message by using the BIC address: DBFCLULL. Instructions received from Clients are validated by CFCL and processed accordingly.

An additional fee will be applied to free format messages, unsolicited instructions and manual repairs to the below instruction types:

- Free format messages; and
- Unsolicited instructions (Swift MT565/MT568/MT599, CFS Portal or File Transfer) where the corporate action reference ID is missing and for which the Client has received this corporate action reference ID previously in the related MT564 notification before sending the instruction. If

several events are announced within the same period, unsolicited instruction might be rejected; and

- Any Client instruction received via Swift MT565, CFS Portal or File Transfer where the required information has been incorrectly populated through dedicated structured fields (manual repairs).

Incorrectly formatted instructions provided via Swift MT565 or CFS Portal that are automatically rejected will immediately trigger a Swift MT567 Status and Processing Advice indicating the reason for rejection.

Instruction format

To ensure straight-through processing and to benefit from the full life cycle of information, Clients must send tax instructions using an available connectivity method:

- Standard rules for the completion of the Swift MT565, as described in the Swift User Guide, must be followed. Any additional information required as described in the tax notification must be included.
- For instructions sent as free-format messages, automatic validation and processing is not applicable.

Free-format instructions can be accepted, containing the following mandatory data to ensure validity:

- Exact event type;
- CFCL Corporate action reference ID (if any);
- Client account number;
- Unique Sender's Message reference (SEME);
- Corporate action option number;
- Corporate action option code indicator;
- Quantity instructed (please refer to the eligible balance on the notification);
- The financial instrument identification number (ISIN or Common Code);
- Tax rate applied for;
- Any additional information required as described in the tax notification.

For BO lists uploaded via Clearstream Fund Centre Upload Beneficial Owner List facility, Clients should submit BO lists in the predefined format. The following data are mandatory to ensure validity of the BO lists:

- Client account number;
- Security code (ISIN or Common Code);
- Security Name;
- CFCL Corporate Action Reference ID (if any);
- Record date;
- Payment date (if applicable);
- Holding;
- Any additional information required as specified in predefined format of a BO list.

Clients must only include one instruction per instruction message. One instruction consists of: one event, one account number, one financial instrument identification number (ISIN or Common code), one tax rate (multiple BOs accepted per same tax rate applied).

If a Client includes more than one instruction per message, or if the additional text field on formatted messages includes an instruction or contradicts with the instruction given in the structured fields, CBL

cannot be held responsible for any loss or damage caused. CFCL reserves the right to reject instructions not formatted as described above.

In the event that Clients do not submit any application for exemption or for reduced tax rate on taxable income or corporate action events, the standard tax rate as per the market specifics (default action) will apply.

Late instructions

Instructions received after the CFCL deadline are handled on a "best efforts" basis, however, execution cannot be guaranteed. If the instruction received after the CFCL deadline cannot be executed, CFCL will apply the standard tax rate as per market specifics (default action) and reject the Client's late instruction accordingly.

When a correctly formatted MT565 instruction comes in after the CFCL deadline, Clients receive an acknowledgement, advising the Client that the instruction is after the CFCL deadline and will be processed on a "best efforts" basis. After feedback from the depositories/agents a revised processing advice is sent to Clients.

Cancellation and replacement of previous instructions by Clients

To replace an instruction already sent, Clients must send a cancellation message before the new instruction.

Clients are requested to cancel formatted instructions with a formatted cancellation (CANC) only (Swift MT565 and CFS Portal).

To cancel and replace free-format instructions, Clients are requested to submit a new free-format message with the reference (SEME) of the free-format instruction to be cancelled and with the new instruction in the additional text of the message.

If instructions have already been processed and forwarded to the local market, the agent or the depository, CFCL will forward the cancellation request accordingly but cannot guarantee execution of the cancellation request.

CFCL cannot be held responsible for any loss or damage caused by the failure of the local market, the agent or the depository to process the cancellation request, nor by a Client's failure to comply with the cancellation and replacement procedure.

Status and processing advice

Clients instructing via Swift MT565 or CFS Portal will receive a status and processing advice message for each tax instruction sent to CFCL.

Clients using CFS Portal can check the status of their instructions directly in CFS Portal and schedule the receipt of an MT567 via Swift.

In order to receive acknowledgements via Swift, a valid Swift address is required and the check boxes for "Acknowledgement of MT565 messages" and "Include all media channels" must be checked in the Scheduled Reports details.

Incorrectly formatted instructions provided via Swift MT565 or CFS Portal that are automatically rejected will immediately trigger a Swift MT567 Status and Processing Advice indicating the reason for rejection.

If the tax instruction was sent using a free-format message, Clients will not receive a status and processing advice and are responsible for monitoring the instruction execution.

Rejection of instructions

CFCL will inform the Client about rejection of instruction in following cases:

- Instruction is incomplete or invalid (as per instruction format definition);
- The corporate action reference ID is missing, ISIN (or common code) and/or corporate action reference ID provided in the related instruction do not match with an event;

- Any additional requirements (as per tax notification) are not satisfied.

Clients will be notified about a rejection via MT567 Status and Processing Advice or via MT568 Swift with a reason of rejection noted.

General disclaimers

In the event that for any reasons, Clients do not receive the expected proceeds as per the tax certification and/or instruction provided to CFCL, the Client shall request CFCL, within a period of three (3) working days from the payment date of the respective income or corporate action event, to perform the readjustment towards, if applicable, the relevant local custodian, paying agent or tax authority.

CFCL shall not be liable in the case where the Client did not request such rectification from CFCL within the above timeframe.

Clients acknowledge and agree that, whenever benefiting from such relief at source or quick refund service, they shall provide to CFCL or the local tax authorities, promptly and upon request at any time of CFCL, such documentation that may be necessary to assist CFCL or its depository to prepare and process via standard refund tax reclaims on behalf of the underlying beneficial owners in order to recover the funds. CFCL shall not be liable in case the documentation is not provided.

CFCL should not, at any time be held liable for any delay, loss or damage caused by any tax documentation being mailed to (and received at) any location other than the one specified in the tax certificate.

Standard reclaims

With its tax services CFCL assists Clients in obtaining tax refunds from taxation in various markets, whenever such service is available via its depository or the tax agent, as specified in our Market Guides,

Clients acknowledge and agree that:

- The tax reclaim service offered by CFCL may be subject to changes depending on the requirements of the local Tax Authorities, local depository or local tax agent; and
- CFCL is authorised to process the tax reclaim with full reliance on the information provided by the Clients, without any requirement for CFCL to verify the authenticity, completeness, accuracy or correctness of any such information and documents; and
- CFCL does not guarantee the acceptance of the reclaim or its payment by the local Tax Authorities, therefore, in the absence of any negligence of CFCL, CFCL shall not be held liable; and
- CFCL shall not at any time be held liable for any loss or damage caused by the tax reclaim procedure unless there is any negligence or wilful misconduct on the part of CFCL, CFCL, however, shall not be liable for any indirect or unforeseeable loss, claim, liability, expense or other damage unless such action or omission constitutes gross negligence or wilful misconduct on the part of CFCL.

Tax refund queries

Clients can query inventory information about tax refunds in CFS Portal. With the tax refund query, Clients can retrieve a list of refunds submitted to CFCL and track their status.

For further information regarding tax refund queries see [Chapter 10. Reports and information services](#).

Tax reports

Regular U.S. withholding tax report

The U.S. withholding tax report enables Clients to verify and reconcile the applied withholding tax rates on their U.S. source income paid on securities in accounts with CFCL. For a full description of the U.S. Withholding tax report, please refer to "File Transfer PDF Report Guide" on the website.

Client Information Form

A Client Information Form is available to notify CFC of the name and address of the contact person/ department to whom the new reports are to be mailed or communicated. If no such information is received, CFC sends all information relating to withholding tax to existing contact names or for the attention of the Taxation/Securities Department.

Client Information Forms are available from the Tax Help Desk or your Client Services Officer or Client Relationship Manager.

8.7 General Meetings Service

CFCL provides a general meetings service to Clients (or to any third party appointed by the Client in accordance with a power of attorney)¹ for Investment Fund Shares held in custody with different service levels as follows:

For each meeting event, Clients will receive, under either service, the respective meeting notification:

- The meeting can be either an AGM or an EGM.

For further details of the market concerned, please refer to the respective market Link information on the website (under Products & Services / Market Coverage / market).

Additionally, CFCL informs Clients about court meetings if and when information is provided to us.

Clients who do not want to use this service have the option to deselect meeting notifications through their CFS Portal.

General Meetings Service

Main features

The main features of the General Meetings service are as follows:

- Notification of meeting events via CFS Portal, File Transfer and via Swift;
- Delivery of meeting agendas, upon request;
- Meeting entitlement notification;
- Split and Partial Voting;
- Meeting Results;
- Power of Attorney for voting;
- Handling of general meetings instructions;
- Delivery of entry or admission cards for meetings, upon request
- Blocking of securities, if applicable;
- Reporting of meeting results if received from the agent;
- Vote execution confirmation.

General meetings instructions can be sent to CFCL using Portal and Swift ISO 20022.

Content of instructions

Standard rules for the completion of the meeting instructions are described in the CFS Portal User Guide and on MyStandards.

CFCL reserves the right to reject message instructions not formatted as per recommendations.

General meeting instructions

The final instruction deadline for meeting events varies from market to market. Clients can send instructions up to the deadline as communicated within the meeting notification. Instructions received after the deadline will be executed on a "best efforts" basis.

Blocking of positions occurs where it is a market or Issuer requirement. Blocking commences when the instruction is submitted to the local market representative, the agent or the depository and continues until the Securities Bloking Period End Date, as communicated in the notification, has been reached.

CFCL performs validations on received instruction messages. The validations can be dependant on certain qualifiers that were used in the notification message (such as non-votable resolution items), on qualifiers used within the instruction that CFCL does not process (such as short positions) or on the specific event and instruction context (such as a registration request without beneficial owner details).

Each received instruction or instruction cancellation will trigger a status message to the instructing party, indicating whether the instruction has been accepted or rejected. Additional status messages will be sent after the instruction is forwarded to the depository, selected provider, or issuer agent. The status message generally requires an active subscription; however, if an instruction is rejected and no subscription is in place, the message with the rejection code will be sent by default to the sender.

Cancellation and replacement of previous instructions

If instructions have already been processed and forwarded to the local market, the agent or the depository, the cancellation request will be handled on a "best efforts" basis.

The cancellation request has to be submitted via Swift ISO 20022 or CFS Portal, and will be processed and forwarded to the depository.

Following an instruction cancellation, clients have the possibility to re-instruct. If a valid Meeting instruction Cancellation Request ID (equal to the Business Message Identifier of the meeting instruction) is included in the new instruction, this is interpreted as a re-instruction. CFCL will process the new instruction only once the cancellation is confirmed by the market provider. If this functionality is not used, CFCL will process it as an individual meeting instruction.

CFCL makes no guarantee as to the execution of such cancellation request and under no circumstances will it be liable for any loss or damage caused by a client's failure to comply with the cancellation and replacement procedure.

Participation methods (instruction) and market specifics

Clearstream Banking supports specific participation methods during the instruction process:

- EVOT for vote instructions;
- PRXY for proxy instructions; and
- PHYS for attendance requests.

Other participation methods are generally not supported.

Each participation method requires dedicated information to be provided:

SCE – Swift Reporting

Meeting Instruction (seev.004) – Participation Method

Instruction	Participation Method	Notification - Supported by CFCL	Instruction - supported by CFCL	Vote Details Section	Meeting Attendee Section	Proxy Section	Securities Registration Indicator	Rights holder section
Vote with/ without Registration	EVOT	✓	✓	Mandatory	Rejection	Rejection	Optional	Mandatory (if requested in seev.001 via „BO Disclosure“ = true)
Attendance	PHYS	✓	✓	Optional	Mandatory	Rejection	Rejection ³	
Proxy with/ without Registration	PRXY	✓	✓	Optional	Rejection	Mandatory	Optional	Mandatory for registration Optional otherwise
Registration	blank ²	n/a	✓ ²	n/a	n/a	n/a	Mandatory	
Not Voting	PHNV	✓	✗	¹ : When received from the market/issuer, the notification will be forwarded with the indicator "Supported By Account Servicer" set to FALSE. Any instructions on those events will be rejected. ² : Please note that Participation Method can only be blank for a Registration-only request. In all other cases, Participation Method is a mandatory field ³ : Entrance card cannot be combined with a registration request. This needs to be instructed with two separate instructions.				
Correspondence	MAIL	✓ ¹	✗					
Virtual	VIRT	✓ ¹	✗					
Proprietary codes		✗	✗					

Figure 8.4 SCE - Swift Reporting

Valid meeting instructions must include key details like ISIN, meeting ID, and account information. For entrance cards without voting rights, participation method PHYS should be used with the PHNV method specified in the meeting attendee section.

Meeting deadlines

The Vote Market Deadline is forwarded by Clearstream Fund Centre as reported by the Clearstream market provider.

The Vote Deadline is determined by Clearstream based on the markets' STP capabilities.

CFCL reports the Vote Market Deadlines and Vote Deadlines in UTC time format (YYYY-MM-DDThh:mm:ss.sssZ).

Clearstream will calculate the deadline on the vote deadline from their depository, the market agent provider or based on the issuer vote market deadline. ?

The vote deadline for events received from issuer agents and where the instructions can be processed STP will be better than the deadlines for events where no instructions in MX format can be sent to the market.

The "Securities Blocking Period End Date" indicates that Clearstream will block the instructed securities from the approval of the instruction to the Securities Blocking End Date.

Please note that date/time fields other than Vote (Market) Deadline may be reported in UTC time format, local time or local time with UTC offset.

Reminders

Following the initial notification and further updates, Clearstream will send reminders to clients for the meeting event according to the following schedule:

- 1st reminder: Seven business days before Early Incentive Deadline;
- 2nd reminder: Seven business days before the Vote Deadline;
- 3rd reminder: Two business days before Early Incentive Deadline;
- 4th Reminder: Two business days before the Vote Deadline.

The reminder service is optional and can be deactivated on subscription level.

Note: A maximum of one reminder is sent per day.

Meeting Vote Execution

The Meeting Vote Execution Confirmation is provided only if explicitly requested in the instruction and if Clearstream receives it from its market provider. Clearstream Fund Centre forwards the received confirmation directly to clients without performing any reconciliation or validation.

The Meeting Result Dissemination

The Meeting Result Dissemination is provided to clients only if Clearstream receives it from its market provider. Clearstream does not verify or reconcile the received meeting results but simply forwards them as they are to the clients.

This page has intentionally been left blank.

9. Communications media

CFCL offers a variety of connectivity methods for order routing and banking services. CFCL offers a unique Client Portal (CFS Portal) and Client can use a variety of connectivity means to send and receive messages (Swift ISO 15022, Swift ISO 20022, File transfer - SFTP and FIX - only for OI).

The reports sent to Clients from CFCL provide details on the status of instructions, as well as account movements, balances and other information. For further details of report content and the media through which they can be received, please see [Chapter 10.Reports and information services](#).

Note: Clients are strongly advised to exercise due care in ensuring and maintaining the security of the communications media by which they submit order instructions to CFCL or receive reports from CFCL.

9.1 CFS Portal

The CFS Portal is a web graphical user interface (GUI), offering streamlined user access to our full range of services from a single-entry point. Clients can access Order Routing, Settlement, Asset Servicing and Cash services via the CFS Portal.

Access and security

- Accessible from anywhere in the world via internet;
- State of the art security, based on internationally recognised standards to ensure the highest security for Clients, whether using a secure public internet connection or virtual private network; and
- Single sign on and User Management, fully customisable at the Client site.

User Guides

The latest versions of the user guides are available on the website.

9.2 File Transfer

File Transfer is a bi-directional data transfer that can be linked and/or fully integrated with any in-house system and various operating platforms.

Designed for secure straight-through processing that can support high-speed and large instruction volumes, rapid distribution of reports that are available in Swift ISO 15022 format, extensible mark-up language (XML), MS Excel (XLS) and portable document (PDF) formats.

Offers Clients a flexible and high-performance communication solution for the exchange of instructions and reports.

Access and security

File Transfer is available via the public internet and offers a communications option via SwiftNet, based on the SwiftNet FileAct service.

Different contingency scenarios are available in the event of network failure and thus provides continuous business and service availability.

File Transfer is available 24 hours a day, six days per week (not available from 22:00 (CET) on Saturdays until 22:00 on Sundays).

Flexible security options enable Clients to control access to their data, network and resources by individual users or classifications of users. Standardised security policies may be implemented across heterogeneous security systems to ensure data protection. Violations are tracked and sources are identified through audit trails and statistics.

User Guide

Details concerning the usage of File Transfer are published on the website in the File Transfer User Guide.

9.3 Swift

Swift connectivity is fully ISO 15022 compliant, secure, fully automated, and able to provide high-speed, high-volume straight-through system-to-system processing. Fund Orders messages are also available in ISO 20022 format.

Access and security

Clients using Swift must exchange authenticator keys with CFCL, as per the rules governing the exchange of authenticator keys set out by Swift and all Swift Message Types used for sending instructions are authenticated messages.

Unauthenticated messages cannot be used to send instructions. Clients can:

- Enter instructions only for those accounts that are linked on CFCL's files to their Swift address.
- Request CFCL to link several of their accounts to one address.

Or

- Use multiple addresses to send instructions for the same account.

CFCL must always be informed in advance of the exact relationship between accounts and BIC destinations.

Clients can send instructions via the BIC address of CFCL.

User Guide

The Swift User Guide provides Clients with an overview of formats and reports available through the Swift connectivity service.

9.4 Vestima and VestimaPRIME order routing via FIX

In order to promote efficient electronic order processing and trade execution CFCL provides an order routing service for investment fund for Order Issuers (OIs) using the FIX connectivity protocol (through a third-party provider, at a cost).

Orders and order cancellation requests received from Clients will be processed by the Vestima and VestimaPRIME platforms. Order statuses and confirmations will be sent back to Clients in FIX messages.

User Guide

The FIX User Guide provides Clients with an overview of the content and format of the messages available through the FIX connectivity service.

9.5 Contingency communication

If the regular communication channel should become inaccessible or unavailable, Clients are recommended to have at least one backup communication channel in place that can be used, as a last resort contingency means of communication and instructions. Information exchanged via facsimile or email, can be temporarily accepted, on condition that a duly signed Letter of Indemnity has been established between the Client and CFCL for such a contingency.

A Letter of Indemnity, signed by CFCL and by the Client, should be established in advance, for all open and new accounts in the name of the Client within its country of operation to ensure a contingency method. (for example, a Letter of Indemnity established with a branch of a supranational corporation in one country will not be valid for other branches of the same supranational corporation in other countries).

Procedure to follow during a contingency situation

For a contingency situation to be accepted by CFCL, the Client must agree to comply with the requirements of the following procedure:

1. Inform CFCL about a presumed contingency situation by contacting CFCL Client Services and/or their Relationship Officer via telephone.
2. Agree with CFCL that there is a contingency situation.
3. Inform CFCL about the contingency communications medium to be used for the duration of the current contingency situation with the Client.
4. Inform CFCL of the end of the contingency situation as soon as possible via telephone, to confirm that the contingency situation has been resolved.

The above procedure shall be applied by the Client every time a contingency situation occurs.

Once the contingency situation is agreed, CFCL will verify whether a valid Letter of Indemnity is recorded in its books.

If, on contingency date, no valid Letter of Indemnity is available for the Client, CFCL will insist that it immediately receives a valid Letter of Indemnity duly signed by authorised persons in the Client's institution.

The Letter of Indemnity shall be sent to the Client via the appropriate communications medium (facsimile or email) and the Client shall return it duly signed to CFCL by the same means. The original of the Letter of Indemnity shall also be delivered promptly to CFCL via postal mail.

Based on CFCL's internal validation of the Client signatures, the process of inputting manual instructions on behalf of the Client can begin.

Only valid and complete instructions containing the necessary level of information detail will be processed.

Note: CFCL will always act on a "best efforts" basis and shall not be held responsible for any delay or any loss, damage, expense that might occur regarding any manually handling instructions, unless such is due to CFCL's gross negligence or wilful misconduct.

The manual setup of Client contingency instructions is subject to fees as published in the CFCL Fee Schedule.

Procedure for establishing a Letter of Indemnity

For a contingency situation to be accepted by CFCL, the Client must agree to comply with the requirements of the following procedure:

1. Inform CFCL about a presumed contingency situation by contacting CFCL Client Services and/or their Relationship Officer via telephone.
2. Agree with CFCL that there is a contingency situation.
3. Inform CFCL about the contingency communications medium to be used for the duration of the current contingency situation with the Client.
4. Inform CFCL of the end of the contingency situation as soon as possible via telephone, to confirm that the contingency situation has been resolved.

The above procedure shall be applied by the Client every time a contingency situation occurs.

Once the contingency situation is agreed, CFCL will verify whether a valid Letter of Indemnity is recorded in its books.

If, on contingency date, no valid Letter of Indemnity is available for the Client, CFCL will insist that it immediately receives a valid Letter of Indemnity duly signed by authorised persons in the Client's institution.

The Letter of Indemnity shall be sent to the Client via the appropriate communications medium (facsimile or email) and the Client shall return it duly signed to CFCL by the same means. The original of the Letter of Indemnity shall also be delivered promptly to CFCL via postal mail.

Based on CFCL's internal validation of the Client signatures, the process of inputting manual instructions on behalf of the Client can begin.

On request and depending on the Client's needs, CFCL Client Services will provide the Client with different templates for their cash and/or Settlement instructions.

Only valid and complete instructions containing the necessary level of information detail will be processed.

Note: CFCL will always act on a "best efforts" basis and shall not be held responsible for any delay or any loss, damage, expense that might occur with regard to any manually handling instructions, unless such is due to CFCL's gross negligence or willful misconduct.

The manual setup of Client contingency instructions is subject to fees as published in the Clearstream Fund Centre Fee Schedule.

This page has intentionally been left blank.

10. Reports and information services

This chapter provides an overview of the reports available via the different communications media currently supported by CFCL and it gives an outline of the information available in each type of report. Technical information appropriate to each medium, and fuller descriptions of the reports together with examples, are given in the user manuals for each communications medium.

Unless advised otherwise within 30 days, CFCL considers the information indicated in Client reports to be accepted and approved by the Client.

10.1 Choice of reports

Settlement, Asset servicing, Tax

Clients can choose from the range of reports available via the connectivity channels described within this chapter. Reporting profiles can be set up that are tailored to their own business requirements. For these profiles, Clients are asked to specify which reports they want to receive/retrieve, and via which communications media. They can do this via the CFS Portal Reporting Centre where they specify the delivery channel, format, frequency and time of the reports they want to receive. Alternatively, Clients can send a Swift MT599 (see Message Exchange) or a subscription form signed by authorised signatories for the attention of the CFCL Connectivity team.

Note: Clients migrating in June 2024 will not be able to subscribe to reports directly via the CFS Portal. CFCL will do it on their behalf upon request.

Cash

Clients can send a Swift MT599 (see Message Exchange) or a subscription form signed by authorised signatories for the attention of the CFCL connectivity team in order to receive cash reports.

Contact: CFCL_Connectivity@clearstream.com

10.2 Reconciliation

CFCL maintains the appropriate reconciliation procedures to ensure the integrity of the securities held in CFCL's system in order to comply with the obligations

Daily Statements and daily reconciliation

Accordingly and in order to enable Clients to comply with their obligations to reconcile their records on a daily basis as set out in the GTCs and Articles 64(3) ESMA RTS, Clients are provided with the following necessary information specified for each Client account and each securities issue, on a daily basis:

- The aggregate balance of each securities account at the beginning of the respective business day;
- The individual securities transfers in or from a securities account during the respective business day; and
- The aggregate balance of a securities account at the end of the respective business day.

Important Note: Clients shall retrieve the above-mentioned information by using existing information channels such as CFS Portal, File Transfer, Swift MT535/MT536.

Reconciliation breaks

When a reconciliation inconsistency or mismatch (referred to as a "break") is detected by the Client following its daily reconciliation process, it must inform CFCL promptly and report it via the Client Service channels. This reporting must be done within the timeframe provided in the GTCs in consideration of the day the Client is open for business (due to the different time zone and banking holidays).

The Client shall provide CFCL with the information that CFCL deems necessary to ensure the integrity of the securities issue and to enable it to solve any reconciliation breaks in accordance with Chapter IX of the ESMA RTS. Where needed, the investigation efforts during reconciliation procedures may imply cooperation and information exchange with third parties involved in the reconciliation process with CFCL. Clients hereby acknowledge and authorise that, according to Article 64(4) of ESMA RTS, CFCL may provide the information referred to above at the request of other holders of accounts with CFCL, to the sole extent that information is necessary for the reconciliation of those holders' records with the records of CFCL.

As a reconciliation resolution measure, CFCL may reverse any credit or debit of securities made to the Client as a result of a break, regardless whether the break is due to CFCL, the Client, another Client or any other person.

Important Note: The Client shall not attempt to take any action to adjust the entry on their own without having informed CFCL beforehand. CFCL shall not be held liable of any losses or damages caused by such direct action of the Client (such as, without being limited to, a direct instruction to a register agent, an issuer agent or a transfer agent or broker outside CFCL's system). In such a situation, the Client shall hold CFCL harmless for any damages, losses, costs (including reasonable fees of counsel), expenses or penalties incurred as a result of their action.

To prevent or solve a break detected, CFCL may in addition take any other actions that CFCL deems necessary to achieve such purpose. CFCL informs the Client without undue delay of such measures.

As a result of the corrective reversal, the Client is solely responsible to cover any shortfall in the relevant account. If they fail to do so, such shortfall will be considered as a securities loss under the GTCs and such loss may be shared with other Clients holding the relevant securities with CFCL. CFCL shall not be liable for the application of such loss sharing provision in accordance with the General Terms and Conditions.

10.3 Connectivity Channels

The communications media: File Transfer and Swift are based on ISO 15022 standards and terminology. As ISO 15022 terminology is used for Message Types, MTxxx applies to these components as appropriate.

CFS Portal supports ISO 20022 format and terminology for securities, otherwise it supports ISO 15022 format and terminology for other banking services.

Swift channel also support order routing messages in ISO 20022 format.

Reports and online queries

The information available via the connectivity channels can be broadly grouped into:

- Clearing and Settlement reports;
- Custody reports;
- Miscellaneous reports;

Clearing and Settlement reports

Clearing and Settlement reports are shown in the following figure:

Report	Description
Statement of Transactions (MT536)	The MT536 Statement of Transactions reports settled transactions impacting the client's aggregate and/or sub-balances.
Statement of Pending Transactions (MT537)	The MT537 Statement of Pending Transactions reports transactions that are not yet booked because they have either a forthcoming Requested Settlement Date or have failed to settle. All statuses or the most relevant status can be reported.
Vestima Transfer Service Statement of Pending Transactions (MT537)	The same report as the MT537 Statement of Pending Transactions, with an additional narrative field that is populated with information recorded in the Relocator module of Vestima.
Settlement Confirmations (MT54x)	The MT544, MT545, MT546 and MT547 Settlement Confirmations report all receive and deliver securities Transactions, free of and against payment, that have settled on the date of the report.
Settlement Status and Processing Advice (MT548)	The MT548 Settlement Status and Processing Advice reports the rejection or Pending status(es) of a previously received instruction or cancellation request.
Vestima Transfer Service Status Advice (MT548)	The same report as the MT548 Statement of Pending Transactions, with an additional narrative field that is populated with information recorded in the Relocator module of Vestima.
Settlement Allegement (MT578)	The MT578 Settlement Allegement reports urgent allegements from Clearstream Fund Centre, Clearstream Banking Luxembourg or Euroclear Bank participants, as well as from the following domestic markets: Austria, Czech Republic, Denmark, Estonia, Finland, France, Greece, Hong Kong, Hungary, Indonesia, Italy, Japan, Netherlands, Norway, Poland, Portugal, Singapore, South Africa, Spain, Sweden, United Kingdom and U.S.A.
Statement of Settlement Allegements (MT586)	The MT586 Statement of Settlement Allegements reports allegements from Clearstream Fund Centre, Clearstream Banking Luxembourg or Euroclear Bank participants, as well as from the following domestic markets: Austria, Czech Republic, Denmark, Estonia, Finland, France, Greece, Hong Kong, Hungary, Indonesia, Italy, Japan, Netherlands, Norway, Poland, Portugal, Singapore, South Africa, Spain, Sweden, United Kingdom and U.S.A.
Confirmation of Debit/Credit (MT900/910)	The MT900 and MT910 Confirmation of Debit/Credit reports debits and credits for pre-selected type(s) of Transactions for all or specified currencies open for the account.

Report	Description
Money Suspense report (MT940)	The MT940 Money Suspense reports all Pending cash transactions, as well as all cash countervalues of against payment securities transactions that are reported in the Statement of Pending Transactions report via Swift MT537. It includes the anticipated net balances and forward balances for the next five Business Days. All statuses or the most relevant status can be reported.
Cash Balances report (MT950)	The MT950 Cash Balance reports cash Balances for all or specified currencies open for the account.
Money Statement (MT950)	The MT950 Money Statement report contains for all or specified currencies open for the account all booked cash Transactions, as well as all cash Countervalues of against payment securities Transactions that are reported in the Statement of Transactions report via MT536.

Figure 10.1 Clearing and Settlement reports

Availability of Clearing and Settlement reports and online queries

The following figure summarises Clearing and Settlement reports and their availability and shows if the equivalent information can be queried using CFS Portal. The report formats available for download via CFS Portal or via File Transfer are also shown.

Note: The times indicated for report availability are approximate and may be subject to delays in processing beyond CFCL's reasonable control. CFCL does not accept any liability for such delays.

Report	Available	Swift	CFS Portal	File Transfer
MT536 Statement of Transactions	Intraday: 01:00; 02:00; 03:00; 04:00; 05:00, 06:30; 07:30, 08:30; 09:30; 10:30; 11:30; 12:30; 13:00; 13:30, 14:30; 15:30; 16:00; 16:30; 17:00; 18:00; 19:00; 21:15; 23:00; 00:00 Daily: 21:15; Weekly: 21:15; Monthly: 21:15	ISO	ISO PDF XLS XML Queries	ISO PDF XLS XML
MT537 Statement of Pending Transactions	Intraday: 01:00; 02:00; 03:00; 04:00; 05:00, 06:30; 07:30, 08:30; 09:30; 10:30; 11:30; 12:30; 13:00; 13:30, 14:30; 15:30; 16:00; 16:30; 17:00; 18:00; 19:00; 21:15; 21:30; 23:00; 00:00 Daily: 21:15 Weekly: 21:15; Continuous: every 15 minutes	ISO	ISO PDF XLS XML Queries	ISO PDF XLS XML
MT537 Vestima Transfer Service Statement of Pending Transactions	Intraday (complete): 07:30; 00:00	ISO	ISO CSV	ISO CSV
MT538 Statement of Intra-Position Advice	Intraday: 01:00; 02:00; 03:00; 04:00; 05:00, 06:30; 07:30, 08:30; 09:30; 10:30; 11:30; 12:30; 13:00; 13:30, 14:30; 15:30; 16:00; 16:30; 17:00; 18:00; 19:00; 21:15; 21:30; 23:00; 00:00 Daily: 21:15; Weekly: 21:15; Monthly: 21:15	ISO	ISO PDF XLS XML Queries	ISO PDF XLS XML

Report	Available	Swift	CFS Portal	File Transfer
MT54x Settlement Confirmations	Via Swift:Real-time Via File Transfer Intraday: 01:00; 02:00; 03:00; 04:00; 05:00; 06:30; 07:30; 08:30; 09:30; 10:30; 11:30; 12:30; 13:00; 13:30; 14:30; 15:30; 16:00; 16:30; 17:00; 18:00; 19:00; 21:15; 23:00; Continuous: every 15-20 minutes	ISO	ISO Queries	ISO
MT548 Settlement Status and Processing Advice	Via Swift: Real-time Via File Transfer Intraday: 01:00; 02:00; 03:00; 04:00; 05:00, 06:30; 07:30; 08:30; 09:30; 10:30; 11:30; 12:30; 13:00; 13:30; 14:30; 15:30; 16:00; 16:30; 17:00; 18:00; 19:00; 21:15; 21:30; 23:00; 00:00; Continuous: every 15-20 minutes	ISO	ISO Queries	ISO
MT548 Vestima Transfer Service Status and Processing Advice	Via Swift: Real-time Via File Transfer Intraday: 01:00; 02:00; 03:00; 04:00; 05:00, 06:30; 07:30; 08:30; 09:30; 10:30; 11:30; 12:30; 13:00; 13:30; 14:30; 15:30; 16:00; 16:30; 17:00; 18:00; 19:00; 21:15; 21:30; 23:00; 00:00; Continuous: every 15-20 minutes	ISO	ISO Queries	ISO
MT578 Settlement Allegement	Via Swift: Real-time Via File Transfer Intraday: 01:00; 02:00; 03:00; 04:00; 05:00, 06:30; 07:30; 08:30; 09:30; 10:30; 11:30; 12:30; 13:00; 13:30; 14:30; 15:30; 16:00; 16:30; 17:00; 18:00; 19:00; 21:15; 21:30; 23:00; 00:00	ISO	ISO Queries	ISO
MT586 Statement of Settlement Allegements	Intraday: 01:00; 02:00; 03:00; 04:00; 05:00, 06:30; 07:30; 08:30; 09:30; 10:30; 11:30; 12:30; 13:00; 13:30; 14:30; 15:30; 16:00; 16:30; 17:00; 18:00; 19:00; 21:15; 21:30; 23:00; 00:00 Daily: 21:15; Weekly: 21:15; Monthly: 21:15; Continuous: every 15 minutes	ISO	ISO PDF XLS XML Queries	ISO PDF XLS XML
MT900/910 Confirmation of Debit/Credit	Via Swift:Real-time Intraday: 01:00; 02:00; 03:00; 04:00; 05:00; 06:30; 07:30; 08:30; 09:30; 10:30; 11:30; 12:30; 13:00; 13:30; 14:30; 15:30; 16:00; 16:30; 17:00; 18:00; 19:00; 21:15; 21:30; 23:00; 00:00	ISO	ISO Queries ISO Queries	ISO
MT950 Cash Balances				
MT950 Money Statement				
MT940 Money Suspense report Money Suspense report value for today				

Report	Available	Swift	CFS Portal	File Transfer
MT290 Advices of Fees and Income				
MT935 Notification of Interest				

Figure 10.2 Clearing and Settlement reports and their availability

Custody reports

Custody reports are shown in the following figure:

Report	Description
Statement of Holdings (MT535)	The MT535 Statement of Holdings reports the holdings that CFCL services for the client. The Complete report contains all holding information. The Delta report contains only changes since the previously sent statement.
Corporate Action Notification (MT564)	The MT564 Corporate Action Notification reports details of a corporate action event along with the possible elections or choices available to the client. It can be initially sent as a preliminary advice and subsequently replaced by another MT564 with complete or confirmed information.
Urgent Uninstructed Notifications (MT564)	The MT564 Urgent Uninstructed Notifications Report provides a regularly updated breakdown of instructed and uninstructed securities Balances related to Corporate Action and Tax breakdowns. Meeting events are not included.
Income Pre-Advice Report - IPAR (MT564)	The MT564 Income Pre-Advice Report provides a forecast on cash and securities proceeds over the five Business Days following the day the report is sent.
Claim and Reversal Advice - CRA (MT564)	The MT564 Claims and Reversal Advice reports detected market claims and reverse market claims subject to compensation by CFCL, as well as the reversal of compensated market claims or reverse market claims and of paid income events.
Corporate Action Confirmation (MT566)	The MT566 Corporate Action Confirmation reports proceeds from income and Redemption events as well as corporate action events which are credited to a clients account.
Corporate Action Status and Processing Advice (MT567)	The MT567 indicates whether a Corporate Action instruction or cancellation is accepted for processing, rejected or denied. It is also sent to clients whose Corporate Action instruction is Pending due to insufficient holding.
Corporate Action Narrative (MT568)	The MT568 Corporate Action Narrative reports extraordinary or general meetings details and resolutions.
US Withholding Tax Report (MT568)	The MT568 US Withholding Tax Report provides a monthly report of U.S. taxable income events including withholding tax rates applied per beneficial owner.

Report	Description
Market Claims Report	<p>The Market Claims Report provides a complete overview by account of potential market claims that are created when the actual Settlement of a security trade takes place after the entitlement date of an associated income or non-income distribution.</p> <p>In addition, the report offers information about CFCL's compensation activities for market claims by providing the current processing status of a claim, together with a related reason code, throughout its life cycle.</p>
The Corporate Action Reference Data Report	<p>The Corporate Action Reference Data Report provides detailed information about corporate actions for any mutual fund held in Clearstream Fund Center, even if Clients do not hold the underlying mutual fund.</p> <p>Clients must submit a list of financial instruments to Clearstream Fund Center via File Transfer via Internet and receive a report with all Corporate Actions Notifications associated with the mutual fund. The report will be sent to their File Transfer FileStore or can be downloaded via CFS Portal. It does not include meeting events.</p>

Figure 10.3 Custody reports

Availability of custody reports and online queries

The following figure summarises custody reports and their availability and shows if the equivalent information can be queried using CFS Portal. The report formats available for download via CFS Portal or File Transfer are also shown.

Note: The times indicated for report availability are approximate and may be subject to delays in processing beyond CFCL's reasonable control. CFCL does not accept any liability for such delays.

Report	Available	Swift	CFS Portal	File Transfer
MT535 Statement of Holdings	01:00, 02:00; 03:00, 04:00; 05:00; 06:30; 07:30, 08:30; 09:30; 10:30; 11:30; 12:00; 13:00; 13:30, 14:30; 15:30; 16:00; 16:30; 17:00; 18:00; 19:00; 21:15; 23:00; 00:00 Daily: 21:15; Weekly: 21:15 Monthly: 21:15; Quarterly: 21:15; Yearly: 21:15	ISO	HTML ISO PDF XLS XML Queries	ISO PDF XLS XML
MT564 Corporate Action Notification	Via Swift: Real-time (Delta) Intraday: 03:00; 08:00; 21:30; 22:30 Continuous (Delta) every 30 minutes via File Transfer	ISO	ISO PDF XLS XML Queries	ISO PDF XLS XML
Urgent Uninstructed Notifications Report	Intraday: 06:00; 10:00; 12:00; 14:00; 16:00; 18:00; 21:30		PDF XML Queries	PDF XML

Report	Available	Swift	CFS Portal	File Transfer
MT564 Income Pre-Advice Report (IPAR)	Via Swift: Real-time (Delta) Intraday (complete): 03:00; 08:00; 21:30; 22:30 Continuous (Delta) when available via File Transfer	ISO	ISO PDF XLS XML Queries	ISO PDF XLS XML
MT564 Claim and Reversal Advice	Via Swift: Real-time (Delta) Continuous (Delta) every 15 minutes via File Transfer	ISO	ISO PDF XLS XML Queries	ISO PDF XLS XML
MT566 Corporate Action Confirmation	Via Swift: Real-time (Delta) Continuous (Delta) every 30 minutes via File Transfer	ISO	ISO PDF XLS XML Queries	ISO PDF XLS XML
MT567 Corporate Action Status and Processing Advice	Via Swift: Real-time (Delta)	ISO	ISO Queries	
MT568 Corporate Action Narrative	Via Swift: Real-time (Delta) Intraday: 03:00; 08:00; 21:30; 22:30 Continuous (Delta) every 30 minutes via File Transfer	ISO	ISO PDF XLS XML Queries	ISO PDF XLS XML
Market Claims Report	Daily: 22:30		PDF XLS XML	PDF XLS XML
Corporate Actions Reference Data Report	Intraday: 06:00; 21:30		ISO PDF XLS XML Queries	ISO PDF XLS XML
Shareholder Identification Disclosure Request (seev.045)	Via Swift: Real-time	ISO	Queries (Only CFS Portal)	XML
Shareholder Identification Disclosure Request Cancellation Advice (seev.046)	Via Swift: Real-time	ISO	Queries (Only CFS Portal)	XML

Figure 10.4 Custody reports and their availability

Free-format message reports

Report	Description
MT568 Corporate Action narrative	Manually generated free format messages sent by CFCL about any topic.
MT599 Free-format report	Manually generated free format messages sent by CFCL about any topic.

Figure 10.5 Free-format message reports

Availability of reports

The following figure summarises the free-format message reports and their availability.

Note: The times that are indicated for report availability are approximate and may be subject to delays in processing that are beyond CFCL's reasonable control. CFCL does not accept any liability for such delays.

Report	Available at	Swift	CFS Portal	File Transfer
MT568 Corporate Action narrative	Via Swift: Real-time Continuous every 15 minutes via CFS Portal and File Transfer	ISO	ISO	ISO
MT599 Free-format report	Via Swift: Real-time Continuous every 15 minutes via CFS Portal and File Transfer	ISO	ISO	ISO

Figure 10.6 Free-format message reports and their availability

Miscellaneous reports

In addition to reports on specific Transactions or Balances, CFC provides other information to Clients to assist in day-to-day account operation and administration. This information includes the following miscellaneous reports:

Report	Description
Notification of Fees (MT290)	The MT290 Notification of Fees reports the total amount of all charges due for the previous month. The MT290 notifies, with a forward date, an impending debit to the account.
Notification of Interest (MT935)	The MT935 Notification of Interest reports a breakdown of the calculation of interest per currency for the previous month. It is available after DTP on the first Business Day following the ninth calendar day of the month.

Figure 10.7 Miscellaneous reports

Availability of reports

The following figure summarises miscellaneous reports and their availability.

Note: The times that are indicated for report availability are approximate and may be subject to delays in processing that are beyond CFCL's reasonable control. CFCL does not accept any liability for such delays.

Report	Available at	Swift	CFS Portal	File Transfer
MT290 Notification of Fees	Generated between the second and fifth Business Days of the month at 21:15	ISO	ISO Queries	
MT935 Notification of Interest	21:15 on first Business Day following the ninth calendar day of the month	ISO	ISO PDF XLS Queries	ISO PDF XLS

Figure 10.8 Miscellaneous reports and their availability

10.4 Monthly billing reports

Fees and charges levied by CFCL for its services are given in the Clearstream Fund Centre Fee Schedule on the website

Statement of Fees

The Statement of Fees is a monthly advice providing a breakdown of individual fees, divided into the following categories: safekeeping, Settlement and cash, custody administration, information provision, miscellaneous fees and additional external charges.

A statement of fees is also sent separately for order routing fees.

Deutsche Boerse's member section

The Deutsche Boerse's member Portal provide easy only access to Client's invoice copies in PDF format.

Once an invoice has been issued the copy version of it can be accessed directly via the Portal. In addition to the PDF invoice copy, XML reports are available for download. The payment status of the Client's invoices is continually updated and reflected there as well. Details on how to register for this service can be found on our website.

10.5 Client documentation

A wide range of technical documentation describing CFCL's products and services is published, including Announcements, the Market Guide, Published Fund List, Securities Timings Matrix, Cash Timings Matrix.

New and replacement pages are published for the Market Guide whenever a new link is launched or changes occur in a domestic market, sometimes together with an Announcement summarising the developments.

For further details about Client documentation, see "[Client publications](#)".

To request further copies of any CFCL documentation, or to amend your mailing details in any way, please contact Clearstream Fund Centre Client Services or your Relationship Officer.

10.6 Registrar Monitoring Report

Clients can subscribe to CFCL Registrar Monitoring Report. This service reports on due diligence information collected by CFCL relating to the agents appointed by Investment Funds available through Vestima. These agents include but are not limited to the TA, registrar and the processing agent registering ownership. The Client will receive the due diligence information relevant to the Investment Fund Shares held as a result of orders routed by CFCL.

The due diligence information is delivered monthly and refers to:

- General information such as the agent's annual report and number of investment funds serviced;
- Regulatory authorisations;

- Auditor details;
- Internal risk and compliance structure;
- Legal information, such as previous or ongoing legal proceedings and insurance cover;
- Operational information and production environment;
- Record keeping such as audit trails and records longevity;
- Key performance indicators;
- Prospectus cross-check; and
- Dedicated financial integrity screening.

CFCL collects this due diligence information and applies a systematic scoring methodology, giving a clear structured overview of each agent in the report provided to the Client. This due diligence information is prepared for general information purposes only based on information made available to CFCL by third parties or publicly available information. The information contained herein cannot be considered as exhaustive and should not be relied upon in that regard. CFCL Clients shall keep such information strictly confidential at all times and shall not divulge any part of it to any third parties, except as required by law or regulators.

CFCL is only responsible for collecting, scoring and transmitting the information and neither makes any guarantees, representations or warranties nor accepts any responsibility or liability as to the accuracy or completeness of the information. The agents remain responsible for the correctness and completeness of the information they provide. This due diligence information is subject to change without notice.

10.7 VestimaPRIME Enhanced Pricing and Reference Data Service (Alternative Funds Data)

Clearstream Fund Centre S.A., offers enhanced alternative fund pricing and reference data services (Alternative Funds Data) for Vestima and VestimaPRIME account holders in conjunction with HedgePole AG (HedgePole) who have been appointed as partner to provide this service.

The specific and detailed scope of performance of the Alternative Funds Data services are defined in separate, written service level agreements (SLA) and subscription terms agreed directly between CFCL Clients and Hedgepole.

Clients can subscribe to the HedgePole Price Collection and Reference Data Maintenance services for investments in alternative funds such as hedge funds and private equity funds and their respective share classes/series which are either:

- Type A: held directly by the CFCL Client and not serviced by CFCL;
- Type B: serviced by CFCL.

For type A funds, the Client provides correctly, in time and at its own expense the services, deliverables, information, data, materials and rights as explicitly agreed, detailed and designated as such in the HedgePole Subscription Form and respective SLA that are required in order to enable Hedgepole to perform the service (Duties of Co-operation). The Client provides the required data in adequate capacity, in pre-agreed format and with adequate performance and security. If the Client fails to comply with its Duties of Co-operation in a timely and comprehensive manner, Hedgepole will inform both the Client and CFCL thereof in writing as soon as practicably possible. Where Hedgepole is not able to provide the Services due to a lack of or inadequate fulfilment of Duties of Co-operation, Hedgepole will call the Client's and CFCL's attention to the lacking or inadequately rendered Duties of Co-operation and its effects in writing and in timely manner - CFCL shall not be responsible for resultant defects in the services. If this prevents Hedgepole from rendering the services within any execution periods, which

may have been agreed upon in the SLA, then agreed execution periods shall be extended by a reasonable period of time.

For type B funds, CFCL will, for all funds serviced by CFCL on the CBL account specified in the Service Subscription Form, provide necessary authorisation to Hedgepole for access to Client data to enable provision of the service. By signing the CFCL and HedgePole Service Subscription Forms, the Client agrees to waive professional secrecy obligations related to the supplied data. The Client hereby agrees and authorises CFCL to:

1. Gather and collect any required information; and
2. Confirm and validate all information;

that the Client does not provide to Hedgepole directly.

More specifically, in addition to providing the necessary authorisation for access to data to enable provision of the service, CFCL will:

- Provide a report for the initial set up of Securities and Accounts by CFCL in Alternative Funds Data to facilitate the onboarding process using Clearstream Fund Centre S.A. automated reporting capacities;
- Provide Hedgepole with historical Prices and fund documentation reasonably required as part of the onboarding process;
- Upon Client instruction:
 - Will seek to resolve any Persistently Non-reporting cases;

When executing a new investment, Clearstream Fund Centre S.A. will ensure that the relevant administrator is instructed to include Hedgepole as interested party to receive the Prospectus, updated fund documents, pricing updates as well as corporate actions notifications on an ongoing basis;

- For Clearstream Fund Centre S.A. serviced funds, once a month (on the first Business Day of the month) Clearstream Fund Centre S.A. will provide Hedgepole with the list of the entire active Pricing Universe for reconciliation purposes;
- Will assist in review of open issues log and agreed resolution actions.

In particular the Client consents to the collection and processing by Hedgepole of the data provided by the Client and CFCL while using the service in order to benefit the Client. The Client will actively support CFCL to collect and provide any information required and not yet available to CFCL. It is the Client's responsibility by accessing, using or providing personal information to or through Hedgepole, to comply with all applicable laws and regulations and the Client accepts to bear all consequences resulting from non-compliance with these requirements.

For type B funds

CFCL (through HedgePole) shall adhere to and agree upon, timelines and deadlines and inform the Client immediately of any delays to those timelines or deadlines as soon as they become evident. Moreover, in the respective SLAs the Parties may additionally provide for binding deadlines, which are of decisive importance for the success of the Services.

CFCL (through HedgePole) always endeavours to comply with deadlines agreed upon in the respective SLAs. CFCL, however, cannot be held responsible for the compliance with deadlines, and the Client is not entitled to assert any claims or remedies of whatever kind due to delays for this service. The Client is not entitled to cancel or rescind the subscription service due to any delay.

For type A and B funds

In subscribing to the service, the Client acknowledges that for the availability, promptness and the correctness of the services, CFCL (through Hedgepole) relies on the performance of third-party data providers including Hedgepole. Therefore, the promptness and the correctness of the Services provided

is to this extent outside the control of CFCL. CFCL cannot be held liable for any damage caused by late, incomplete or incorrect information provided by such third-party data providers, CFCL will also not be liable for any damages arising from the unavailability or incorrectness of the services from such third parties for whatever reason.

The Client (or any of its affiliates) may not operate, access, or alter the systems operated, and the processes and infrastructure installed by Hedgepole, without approval of Hedgepole. The Client shall observe any and all written instructions by Hedgepole on the use of hardware and software.

CFCL does not assume any obligation to deliver particular results unless explicitly agreed so in writing in any SLA.

CFCL in no case bears any responsibility for the performance by Hedgepole and does neither assume any responsibility nor liability for the compatibility of services performed by Hedgepole. All consequences of the use of services performed by Hedgepole are at the Client's sole risk and responsibility.

Notwithstanding the above, CFCL shall be liable towards the Client under the subscription service for losses or other damages caused by Hedgepole's or CFCL's wilful misconduct or gross negligence. Any further liability of CFCL towards the Client or third parties under any title and of any nature whatsoever, including any liability for indirect and consequential damages, for loss of data, for additional expenses or claims of third parties, and for loss of profit or non-realised savings, is, regardless of the cause of action and to the maximum extent legally possible, excluded. CFCL shall not be liable for damage caused by acts beyond CFCL's control, including force majeure events.

Any liability of CFCL towards the Client for damage caused by hardware, systems, installations or software which are not directly or indirectly used or delivered by CFCL (through Hedgepole), or which are transferred to or put at Hedgepole's disposal by the Client is excluded.

The Client is entitled to reflect Alternative Funds Data as part of the normal provision of order routing, custody and settlement service to their Clients. The Client shall be prohibited from:

1. Distributing the Services provided by HedgePole to any other third party;
2. Authorising any other third party to link to, or use, the applications made available or services provided by CFCL (through HedgePole) under this section of the Client Handbook; and
3. Making any report or data provided by CFCL (through HedgePole) available, in any form, to any other third party.

This page has intentionally been left blank.

Glossary

This Glossary is intended for information purposes only and is designed to help clients to understand the terminology used by CFCL in this Handbook. In some cases, the way in which the terms are used in CFCL may differ from how the terms may be applied in another context. The descriptions given are not to be considered as legally binding definitions of the terminology used.

CFCL gratefully acknowledges that some definitions given here are based on those used by the Group of Thirty, the International Society of Securities Administrators (ISSA), and in other market publications.

A

Account Holder

The **client**.

Account Option

The Account Option determines whether internal **transactions**, and Euroclear deliveries for **settlement** sequence purposes only, are included automatically in the optional settlement processing. Account options consist of the **default option** or a **standing instruction**. They can be overridden on individual **transactions** using an **instruction flag**.

Actual settlement Date

See Settlement date.

Anticipated Net Position

A projection of the posted **Balance D+1** which can be used as a guide to **Funding** by **value date**.

B

Back-to-Back Transactions

In the context of CFCL, separate sale and purchase **Transactions**, for the same **Requested settlement Date**, in the same **settlement** processing and for **settlement** over a **Client's** account where the securities Provision on the sale is provided by the purchase and the funds for the purchase by the proceeds of the sale. See also **Chaining**.

Backvaluation

The debit or credit of funds with a **value date** that precedes the **settlement Date** of the **settlement** processing in which the **Transaction** is reported as settled or confirmed. Securities cannot be backvalued on a **Client's** account: they can only be settled from the processing in which they are credited.

Balance

The segregated holding, in either securities or cash, within the overall position held in an account resulting from the **settlement** of **Transactions**.

BD

Business Day.

Book-entry

A method whereby transfer of ownership of securities is affected by debits and credits to accounts without the need for the movement of physical **Certificates** or documents.

Business Day

Unless otherwise specified, a day on which CFCL's Head Office in Luxembourg is open for business.

Buy-In

Action taken by the party failing to receive delivery of securities from a counterparty on **settlement Date** to purchase these securities in the open market. Rules for Buy-In are defined by the **ICMA**.

C

Cash Correspondent

An appointed by CFCL, as its agent, to handle external receipt and payment of funds in a specified currency.

CBF

See Clearstream Banking Frankfurt.

CBL

See Clearstream Banking S.A.

CFCL "service network"

The **Clearance** and **settlement** system operated by CFCL. The CFCL "service network" encompasses a network of service providers (**Financing Banks, Cash Correspondents and Depositories**) to which **Clients** have indirect access through their accounts with CFCL.

CCP CD

Central counterparty.

Central Facility for Funds (CFF) Services

The CFCL post-trade infrastructure for **Investment Funds**.

Certificate(s) - internet browser

A Certificate specifies the name of an individual or an entity and certifies that the public key, which is included in the Certificate, belongs to that individual or entity.

Certification Event Date

Dates, notified to **Clients** by CFCL, by which certificates of beneficial ownership must be submitted to CFCL by holders of **Euro-instruments**.

Certification - Investment Funds

Confirmation, from an **Order Issuer (OI)**, sent either directly to the **Order Handling Agent (OHA)** or through Clearstream Fund Centre, that the OI or its **Client** complies with the terms and conditions / governing documentation of the **Investment Fund**.

CFS Portal

Client online portal for clients to be able to manage their assets through CFCL services and products.

CFCL

Clearstream Fund Centre S.A.

CFCL Deadline - Investment Fund

The time defined for each Fund by which orders must be received by CFCL to ensure forwarding to the relevant Order Handling Agent (OHA) in time for the Fund's next cut-off time.

Clean Payment Order

An instruction to withdraw or transfer funds without an associated transfer of securities.

Clearance/Clearing

In the context of CFCL, **Clearing** means the entire processing of a **Transaction**, from receipt of the **instruction**, through **Matching** and the various status levels in Suspense, to final **Settlement** and accounting. The final **Clearance** of the **Transaction** is the process of determining accountability for the exchange of cash and securities between the **counterparties** to a trade; Clearance leads to new book-entry **Balances** and positions in securities and/or funds.

Clearstream Fund Centre deadline - Investment Fund

The time defined for each Fund by which orders must be received by CFCL to ensure forwarding to the relevant **Order Handling Agent (OHA)** in time for the Fund's next cut-off time.

Clearstream Banking Frankfurt (CBF)

Formerly Deutsche Börse Clearing, from 1 January 2000 a subsidiary company of Clearstream Holding AG. Located in Frankfurt, it handles the **settlement** of foreign securities on behalf of its German **Clients**

and the **settlement** of German securities traded between its German **Clients** and **counterparties** with accounts in external **Clearing** systems such as CFCL.

Clearstream Banking S.A. (CBL)

Effective 1 January 2000, Cedel merged with Deutsche Börse Clearing to form the new entity of Clearstream International, jointly owned by Cedel International and Deutsche Börse AG. Clearstream Banking S.A. (CBL) is a subsidiary of Clearstream Holding AG and carries out the traditional business of the former Cedel- **Clearing, settlement** and custody. Other subsidiaries include Clearstream Banking Frankfurt (CBF) and Clearstream Services.

Client

A legal person or entity, whether public or private, that has been accepted by CFCL as a Client.

Collateral

Property that is Pledged as security for the satisfaction of a debt or contingency.

Collateral Provision

See Provision.

Common Depository (CDs)

A Common Depository is one jointly appointed by Clearstream Banking and Euroclear to hold and to service securities in either Classical Global Note (CGN) or book-entry form.

Communications User Manuals

Documents that set out the procedures, options and formats to be followed by **Clients** according to the method of communication used. Communications user manuals include the Swift User Manual and such other documents as CFCL may from time to time so designate. Communications User Manuals are Governing Documents if designated as such by CFCL upon publication.

Confirmed Funds

Funds credited to a Client account upon receipt by CFCL of confirmation from CFCL's Cash **Correspondent** (in the case of **Pre-advices**) or from a clearing system or **Depository** (in the case of external against payment deliveries) of a receipt of funds.

Counterparty

One party to a trade or **Transaction**. A trade takes place between two **counterparties**. Usually, one party to a trade refers to its trading partner as the counterparty.

Countervalue

The cash amount to be received in return for a specified delivery of securities.

Cross-CSD settlement

Settlement between two Clients located in different CSDs.

CSD

Central Securities Depository.

Currency Code

The three-letter ISO code used by CFCL to identify a specific currency.

The three-letter ISO code used by CFCL to identify a specific currency.

D

Deadline

Latest time for submission of **instructions** for inclusion in the processing for the **Requested settlement**

Date. All deadlines quoted in hours and minutes (hh:mm) should be understood to include ":00" seconds. For example, 16:00 should be understood to mean 16:00:00.

Default Option

With reference to the optional **settlement** flag, the Default Option is the **Account Option** that applies unless the Client requests a **Standing instruction**. Internal **Transactions** and Euroclear deliveries on accounts using the Default Option are automatically excluded from the optional **settlement** processing, except if the **Client** uses an **instruction Flag** on specific **instructions**.

Delivery Against Payment / Delivery Versus Payment

The irrevocable exchange of securities (the delivery) and cash value (the payment) to settle a **Transaction**. True Delivery Against Payment involves the simultaneous exchange of securities and cash, as in the case of internal **Transactions** between CFCL counterparties.

Delivery Free of Payment

A **Transaction** for the irrevocable delivery of securities from a CFCL account without an associated payment of funds to the CFCL account.

Dematerialisation

The elimination of physical Certificates or documents of title.

Depository

Clearing system to which CFCL entrusts the safekeeping and administration of securities that CFCL holds on behalf of its Clients. Depositories also administer the receipt and/or delivery of securities into/out of the CFCL "service network".

Direct File Transfer

A system-to-system communication channel.

Distribution Date

In CFCL, Distribution Date corresponds to the **settlement Date** of the processing in CFCL into which a New Issue is entered for distribution. On a regular Closing, the Distribution Date is the **Business Day** after **Closing** date, as this is the **settlement Date** of the real-time processing in which the **New Issue** is distributed.

Dividend

Allocation of a portion of company profit to shareholders. Dividends are paid pro rata to the number of shares held and are normally paid in cash, although they may also be paid in the form of shares (stock Dividend).

Domestic counterparty

A counterparty that has contracted with a CFCL Client to settle outside CFCL and Euroclear. See External instruction.

DVP

Abbreviation for Delivery Versus Payment. See Delivery Against Payment.

E

EFC

European Fund Classification.

EFAMA

European Fund and Asset Management Association.

ESMA

European Securities and Markets Authority.

Estimated settlement Date

For external **Transactions**, the date on which CFCL estimates that **settlement** of a **Transaction** will take place in the domestic market. For each external **Transaction**, there is a fixed period that elapses between the processing from which the **Transaction** is released to the **Domestic Depository** for **settlement** and the Estimated settlement Date. The Estimated settlement Date corresponds to the **Requested settlement Date** if the **instruction** is input by the **Client** by the relevant **instruction deadline** and is released by CFCL in the corresponding **settlement** processing. For the Countervalue on external

against payment deliveries, the Estimated settlement Date is the anticipated **value date** of the funds to be received. See also **settlement Date**.

Euroclear Bank

Operator of the Euroclear System (commonly known as Euroclear or EOC).

Ex-Date

The date on which shares or **Investment Funds** are traded without corporate action entitlement; for example, **Dividend**, purchase right etc.

External counterparty

A **counterparty** settling with an account in a domestic market.

External-CSD settlement

Settlement between a CFCL Client and a Client located outside CFCL.

External instruction

An instruction for receipt or delivery of securities from or to a **domestic counterparty** (or, in the case of physical Transactions, any delivery destination outside CFCL, CBL and Euroclear).

External settlement

Settlement between a CFCL Client and a Client located in domestic CSD.

F

Fail/Failed Transaction

A securities **Transaction** that fails to settle, either at all or on time.

FIA

See Fund Issuance Account.

Filter Code

A code that determines whether an **instruction** is eligible for inclusion in the optional **settlement** processing. The Filter Code is applied by a **Standing instruction** on the account, and/or by an **instruction Flag**. If the **Client** does not have a **Standing instruction**, and has not used an **instruction Flag**, the **Default Option** applies, and no Filter Code appears on **Client** reports. See also **Account Options**.

Financing

Cash or securities facility administered or provided by CFCL.

Financing Bank

The bank that provides **Funding** and accepts principal risk in respect of the **Financing** of **Client Transactions** for **Clearing** and **settlement** in CFCL.

FIX

The Financial Information eXchange (FIX) protocol is an electronic communications protocol for international real-time exchange of information related to securities transactions and markets.

Flexible

The criteria used in the Security **settlement Sequence Options** chosen by the **Client** can be **Strict** or **Flexible**. If the criteria are **Flexible**, the first **Transaction** in the **Transaction Queue** is considered first, but, if it does not settle, then **Transactions** in the same security that are further down the queue will be considered for **settlement**.

FMA

See Fund Market Account.

FPG

Fund Processing Group

Free of Payment

A transfer of securities without an associated transfer of funds.

Fund Issuance Account (FIA)

The account opened in the CFCL system in the name of a **CFF Settlement Agent** and used exclusively for **CFF Services** for credits and debits of **CFF Qualified Investment Fund Shares** and **related settlement Transactions**.

Fund Market Account

A technical intermediary account to facilitate the **settlement** between the **Order Issuer** and the Order Handling Agent. For the avoidance of doubt, its use does not imply that CFCL is a party to the trade or the transfer of the **Investment Fund Shares** being settled.

Fund Reference Data

A set of data, either static or dynamic, relating to an **Investment Fund**.

Funding

Funds transferred to CFCL by a **Financing Bank** in accordance with the terms of a **Financing** agreement, to cover an overdraft on a CFCL **Client's** account.

Fungible

In CFCL, a Fungible **Balance** represents a **Nominal Amount** of securities from a pool of interchangeable securities of the same **Security Code**.

G

Governing Documents

The **General Terms and Conditions**, **Client Handbook** and **Communications User Manuals**, which may be amended from time to time, and such other documents as CFCL may, from time to time, so designate. The Governing Documents describe the overall contractual relations between CFCL and its **Clients**.

I

ICMA

International Capital Market Association (created in July 2005 by the merger of the International Securities Market Association (ISMA) and the International Primary Market Association (IPMA)) is an organisation with a broad franchise across the primary and secondary international capital market. This association has the mandate and the means to represent the interests of the investment banking industry in maintaining and developing an efficient and cost-effective international market for capital.

Instruction

An authenticated message from a Client to execute a transaction. See also Internal instruction, Investment Fund Order, External instruction, Transaction.

Instruction flag

Instruction flags can be used on specific **instructions** to override the **Client's account option**. See also **filter code**.

Intended Settlement Date (ISD)

Please refer to "Requested Settlement Date".

Internal counterparty

A **counterparty** settling with an account in CFCL.

Internal instruction

An **instruction** for a **Transaction** by **book-entry** between CFCL accounts or between **CFCL** and **CBL** accounts.

International Central Securities Depository (ICSD)

A **Central Securities Depository** that provides **Clearance** and **settlement** of **Transactions** in global and **International Securities** and **domestic Securities** traded across borders.

Investment Fund

An undertaking for collective investments, in whatever legal form, for example, constituted as unit trust/common fund or as an investment company, which are accepted for order routing through Clearstream Fund Centre.

Investment Fund Order

An order of **Investment Fund Shares** (including but not limited to redemption, subscription, switch and cancellation requests) issued by an **Order Issuer (OI)**.

Investment Fund Register

A register held by the **Investment Fund** or by a **Transfer Agent (TA)** on behalf of an Investment Fund, to record and evidence entitlement in the respective **Investment Fund Shares**.

Investment Fund Share

Any security issued by an **Investment Fund**. The smallest unit of an Investment Fund.

IPAR

Income Pre-Advice Report. Provides Clients with information about future cash and securities proceeds and capital repayments for all the securities that are held in their accounts.

ISMA

International Securities Market Association - see ICMA.

ISIN

International Securities Identification Number. A coding system developed by the ISO with the purpose of creating one unique number on a world-wide basis for identifying securities in accordance with ISO standard 6166. The ISIN for each security consists of a 12-digit alphanumeric code. The prefix is a two-letter country code.

ISO

International Organisation for Standardisation. The international federation of standardisation bodies for various industries that seeks to set common international standards in a variety of fields.

Issuer

A company, or government body, which borrows or raises funds through the sale of securities.

Issuer Agent

A generic term describing an entity that acts on behalf, and upon request, of the Issuer. The term "Agent" includes any Principal Paying Agent, Issuing and Paying Agent, Fiscal Agent, Registrar, or any other agent appointed by the Issuer.

Issuer - ICSDs Agreement

Standard form agreement between the **Issuer** and the ICSDs in relation to the acceptance of securities in **New Global Note** form.

Issuing Agent

Under the terms and conditions of an issue or facility, the agent responsible for arranging the issue of notes or **Certificates**.

L**Letter of Request to Clearstream Fund Centre for Reclaim of Withholding Tax**

This authorises CFCL to reclaim withholding tax from the local tax authorities on the Client's behalf. Market specific versions are available in the relevant Market Taxation Guides.

One of the two types of cash penalties. LMFP applies due to the matching taking place after the ISD.

M**Matching, Matching for settlement**

The process that compares the mandatory **settlement** and optional trade details given by the two **counterparties** to a trade in their **instructions**. **Presettlement Matching** makes this comparison for information purposes. **Matching for settlement** takes place as part of the **settlement** process on the basis of actual **Transactions** presented for **settlement**.

Message Type (MT)

Refers to Swift Message Types that can be used by **Clients** to send **instructions** and messages, and to receive reports. For example, "MT54x" refers to Message Types 540, 541, 542 and 543.

Mifid

Directive 2014/65/EU of the European Parliament and of the Council of 15 May 2014 on markets in financial instruments and amending Directive 2002/92/EC and Directive 2011/61/EU.

N

Next Day Currency, Next Day Funds

In CFCL, a currency in which the latest **instruction deadline** is one **Business Day** before the requested value date.

Nominal Amount

Face value.

O

On-delivery / On-sale

A **Transaction** to deliver/sell securities received through a receipt/purchase **Transaction** that provides the necessary **Provision** for the onward sale.

Order Confirmation

The confirmation sent by an **Order Handling Agent (OHA)** that an **Investment Fund Order** from an **Order Issuer (OI)** has been processed.

Order Handling Agent (OHA)

Order Handling Agent (OHA) The legal entity, accepted by CFCL as a **Vestima Participant**, which receives **Investment Fund Orders**.

Order Issuer (OI)

The legal entity, accepted by CFCL as a **Vestima Participant**, that issues **Investment Fund Orders**.

OTC

Over the counter, that is, (of a **Transaction**) arranged other than in a stock exchange.

P

Pending

In CFCL, Pending **Transactions** are those that have reached the Processing Date for **settlement** but which are withheld from the **settlement** processing awaiting confirmation of the occurrence of an event. Examples are **Transactions** in **New Issue** securities where confirmation of actual Closing is awaited; and **Transactions** released for purchase of securities in a domestic market where confirmation of **settlement** is awaited from the CFCL **Depository** or **Clearing** system in the domestic market.

Physical Delivery

Delivery of definitive or material **Certificates** in a security. More commonly, ownership of securities is transferred by means of **Book-entry Transactions**.

Pledge

To give or deposit as security **Collateral** to cover **Financing** or credit facilities provided by or through CFCL.

Pre-advice (MT210 Instruction)

Instruction from a **Client** to inform CFCL that funds are to be transferred to a CFCL **Cash Correspondent** for a specified value date. **Clients** send pre-advices to ensure that funds are applied with good value.

Presettlement Matching

See Matching.

Primary Market

The market in which securities are first issued, subscribed and distributed.

Primary Market Order

A **Vestima** order routed to an **Order Handling Agent (OHA)** for execution on the **Investment Fund Register**. A Primary Market Order can be either a subscription, a redemption or a switch, and results in **Investment Fund Shares** being issued and/or redeemed.

Priority Code

Transactions that have a Priority Code are given prior consideration in the allocation of available **Provision** for the Security **settlement** of **Transactions** over an account. The sequence in which **Transactions** over an account are considered for **settlement** is also affected by the Security **settlement Sequence Option** selected by the **Client** for the account. A Priority Code can be input by the **Client** when the **instruction** is first submitted to CFCL or, subsequently, while the **instruction** is in **Suspense**.

The Client cannot input a Priority Code on **cash instructions**.

Private Placement

Sale of an entire issue of securities, or of a specific tranche of an issue, to a small group of subscribers without a public offering.

Processing Date

The date on which the **Transaction** is taken from the Suspense file to be considered for **settlement** by CFCL. In the case of internal **Transactions**, the Processing Date is the same as the actual **settlement Date** of **Transactions** settled in the **settlement** processing. In the case of external settlement, the Processing Date of the **Transaction** normally precedes the Requested settlement Date, in order to ensure that timely presentation is made for **settlement** in the domestic market according to the conditions that apply in that market.

Professional Securities Intermediary

Regulated financial institutions, whose license covers the intermediation of securities and custody services, and who conduct the intermediation of such services as part of their regular business activities. This definition generally applies to central banks, central counterparties, central securities depositories, depository banks, custodians and transfer agents.

Promoter

The Promoter of an **Investment Fund**.

Provision

The availability of cash or securities on an account to execute a **Transaction**. Cash Provision is resourced by account **Balances** and **Financing** facilities. Securities Provision is resourced by account **Balances** and securities borrowing facilities. **Collateral Provision** refers to all cash and securities accepted by CFCL used to secure risks and contingencies on an account.

Published Fund List

CFCL's service providing Clients with automated daily reporting on Investment Fund Reference data.

R**Receipt Against Payment / Receipt Versus Payment**

The irrevocable payment of cash upon presentation of securities (the receipt side) to settle a **Transaction**. True Receipt Against Payment involves the simultaneous exchange of securities and cash, as in the case of internal **Transactions** settled in CFCL by book-entry.

Receipt Free of Payment

A **Transaction** for the irrevocable receipt of securities into a CFCL account without an associated payment of funds from the CFCL account.

Recommended deadline

Recommended **deadlines** are given by CFCL where operational constraints mean that CFCL or CFCL's agent cannot guarantee to process **instructions** received after the Recommended deadline but before the final **deadline**. Therefore, any **instruction** received after the Recommended deadline is at the **Client's** own risk.

Record Date

The date, established by an **Issuer** of a security, used by CFCL to determine, at the end of that day (that is, after End of day processing) the holders that are entitled to a corporate action.

Requested settlement Date

The date given by the Client for settlement of the Transaction; the term has the same meaning as Intended Settlement Date.

S

Same-Day Currency

A currency in CFCL in which funds are available with value date the same as the date of the instruction.

SDR

Commission Delegated Regulation (EU) 2018/1229 of 25 May 2018 supplementing Regulation (EU) No 909/2014 of the European Parliament and of the Council with regard to regulatory technical standards on settlement discipline.

Full text available [here](#).

Security Code

Code used to identify a specific security. For example: common code, ISIN.

Settlement

The completion of a **Transaction** or of processing with the aim of discharging participants' obligations through the transfer of funds and/or securities, wherein securities and corresponding funds are delivered and credited to the appropriate accounts.

Settlement Agent

A legal entity whose account is used to settle on behalf of another legal entity.

Settlement Date (Actual)

The date on which ownership of securities traded actually passes from deliverer to receiver. In the case of against payment **Transactions**, this is normally also the **value date** due for payment of the funds **Countervalue**. According to the terms of the trade agreed between the **counterparties**, delivery is to occur at a particular location and over specified accounts. See also **Estimated settlement Date**, **Requested settlement Date**.

For **internal Transactions**, the date that **Transactions** are processed for **settlement** in the CFCL **settlement** processing (in which simultaneous book-entry transfer of securities and cash occurs) is the settlement Date,

In the case of **external delivery Transactions**, the date of the debit of securities to the **Client's** account in CFCL does not necessarily represent the **Actual settlement Date** of **settlement** in the external clearing system. The **Actual settlement Date** is determined by the external clearing system upon receipt of the **Transaction** from CFCL and is normally evidenced in CFCL by the value date applied to the funds **Countervalue** when credited by CFCL. However, if **settlement** occurs before the **Estimated settlement Date**, the value date is the Estimated settlement Date and not the Actual settlement Date. On external deliveries **Free of Payment**, **settlement Date** for securities, which is not reported in CFCL, is independent of the transfer of the funds **Countervalue**.

On **external receipts against payment**, **settlement Date** in the external clearing system is evidenced by the **value date** of the funds book-entry in CFCL (except when **settlement** occurs before the **Estimated settlement Date**, when the same rule applies as for external deliveries, described above). However, availability of securities for **On-sale** in CFCL is determined by the CFCL processing into which the confirmation of **settlement** of the **Transaction** is entered for book-entry in CFCL.

Furthermore, according to market practice in the domestic market, which is reflected in the conditions of the trade, rights of ownership and entitlement may change on **Trade Date** or on **Record Dates** that precede the **settlement Date**.

Settlement Sequence Option

According to their own business needs, **Clients** can select one of four Security **Settlement Sequence Options** on an account. The Settlement Sequence Option chosen determines the criteria by which **Transactions** for **settlement** over the account are sequenced for use of the available **Provision** unless a **Priority Code** is given. Settlement Sequence Options cannot be changed on a day-to-day basis.

Short selling

Short Selling is the selling, the transfer or the delivery, whether free or against payment, of an asset that the **Client** does not own in its Clearstream account.

Standing instruction

A Standing instruction is either:

An **Account Option** specified by the **Client** to ensure that all internal against payment **Transactions**, and Euroclear instruction against payment deliveries for **settlement** sequence purposes only, are automatically included in the optional **settlement** processing, unless the Account Option is overridden on specific **instructions** using an **instruction Flag**.

or

Settlement related data provided by **Order Issuers (OIs)** and **Order Handling Agents (OHAs)** to enable the routing of **Investment Fund Orders** and the optional generation of **settlement instructions**.

Swift

Formal abbreviation of the Society for Worldwide Interbank Financial Telecommunication.

T**TA**

See Transfer Agent.

T2 RTGS

T2 RTGS is a real time gross settlement (RTGS) system which is complemented by a central liquidity management (CLM) system that optimises liquidity management across all Target services.

Trade Date

The date on which a trade is executed or made. For **CFF Services**, this is the effective register date, which records ownership in the relevant **Investment Fund Register**.

Trade Price

The price or rate agreed between **counterparties** to a trade.

Transaction

A combination of two instructions that leads to a transfer of ownership from an account to another.

Transaction Queue

Transactions over a **Client's** account are ordered in a Transaction Queue according to the **Settlement Sequence Option** on the account.

Transfer Agent (TA)

The agent appointed by the **Investment Fund** to process **Investment Fund Orders** and perform ancillary services.

U**Umbrella Credit and Collateral Services (UCCS)**

Umbrella Credit Facilities permits the sharing of credit limits and Collateral across Client accounts.

Underlying Client

A Client of the CFCL Client.

U.S. Withholding Tax Report

Provides a monthly report of U.S. taxable income events, including withholding tax rates applied per beneficial owner, to enable **Clients** to verify and reconcile the applied withholding tax rates on their U.S. source income paid on U.S. securities held with CFCL.

V**Value date**

The date applied by CFCL for the purposes of interest calculation to funds debited from or credited to an account.

VEN

"Valeurs Essentiellement Nominatives" Essentially Registered Securities.

Vestima

CFCL's automated order-routing service for the **Investment Funds** industry. It provides a point of access to Investment **Fund** market participants (distributors, custodians, asset managers, administrators), simplifying and standardising trading in **Investment Fund Shares** and related settlement processing. Provision of **Vestima** services by CFCL is subject to the signature of specific Vestima terms and conditions.

Vestima Participant

An organisation or individual that uses **Vestima**.

VestimaPRIME

CFCL's automated order routing service for Clients whose primary portfolio contains complex and alternative Investment Funds, with bespoke solutions for order entry, monitoring and reporting.

VON

"Valeurs Occasionnellement Nominatives" Occasionally Registered Securities.

Contact:
www.clearstream.com

Published by
Clearstream Fund Centre S.A.

Registered address
Clearstream Fund Centre S.A.
42 Avenue John F. Kennedy
L-1855 Luxembourg

Postal address
Clearstream Fund Centre S.A.
L-2967 Luxembourg

16 December 2024

Document number: 7379
